



CABLE BROADBAND

The Benefits and Challenges of Deploying 5G Small Cells on the HFC Strand Network

CAMERON GILLIS

SR. MANAGER, NETWORKS BUSINESS
SAMSUNG ELECTRONICS AMERICA

RILEY LEHECKA

SENIOR PRODUCT MANAGER
ENERGY SYSTEMS/ENERSYS

CHARLES CHAPMAN

SENIOR TECHNICAL SALES REPRESENTATIVE, ENERSYS
CHAIR OF THE SCTE DSS IOT SMART CITY WORKING GROUP



1	Introduction
3	The 5G Strand Use Case
3	MVNO Data Offload
5	Business Case
6	The HMNO Network
6	HFC Architecture
7	Coax Power Distribution
8	5G CBRS HMNO Architecture
9	HMNO DSDS Device Capability
10	Wireless Spectrum and DOCSIS
14	Other Spectrum Bands
15	5G Strand Small Cell Engineering
16	Form Factor - Physical Characteristics
19	Power and DOCSIS
30	Antennas
38	Network Design and Optimization
40	Coverage and Capacity Planning
40	Mobility
42	Deployment and Operations
44	Conclusion
45	Abbreviations
47	Endnotes



INTRODUCTION

Cable/Multiple System Operators (MSOs) offering mobile phone services are some of the fastest growing mobile service providers in the US Market. The two largest MSOs, Comcast and Charter, have a combined total of over 12 million mobile subscriber lines as per their latest quarterly earnings reports. The MSOs are buying spare capacity from existing mobile operators to serve their subscribers, which labels them Mobile Virtual Network Operators (MVNOs). These MSOs have a key advantage over other mobile operators in that they can now utilize new technology to leverage their existing hybrid fiber coax (HFC) network to overlay a 5G mobile network. Comcast, Charter and Cox invested a combined \$1.1B in Citizens Broadband Radio Service (CBRS) licenses in 2020 as part of the Federal Communications Commission (FCC) Auction 105¹. They can now use those frequency licenses and their HFC network to surgically target areas to build out their own mobile network that will coexist with the network capacity that they are buying from existing mobile operators to make them a Hybrid Mobile Network Operator (HMNO).

Strand-mounted 5G small cell radio can be deployed directly on the HFC aerial strand available in many cities in the United States. Attaching this small cell radio to the existing HFC network solves some of the biggest problems a mobile network operator faces when deploying a new greenfield network:

- **SITE ACQUISITION** - hanging on the strand requires no permissions or pole attachment fees.
- **POWER** - the strand-mount small cell radio derives its power from the existing coax infrastructure.
- **BACKHAUL** - the strand small cell utilizes an embedded Data Over Cable Service Interface Specification (DOCSIS®) cable modem (CM) for backhaul.

While offering many benefits, deploying a small cell on the communications strand roughly 20 feet above the ground comes with some engineering challenges. This paper will detail the functional components which make up a strand-mounted small cell radio and how those components are packaged together to meet both cable network and wireless network engineering considerations.

Cable network engineering considerations include:

- Optimizing power consumption for maximum performance.
- Supporting flexible cable modem frequency splits across different MSOs.
- Preventing ingress/egress/spurious noise to isolate DOCSIS coax RF from wireless RF.

Wireless network engineering considerations include:

- Antenna design, form-factor, and gain.
- Wireless coverage and capacity planning.
- Utilizing optimum radio network components to maximize data offload performance.

This paper will give the reader an understanding of what needs to be considered as part of designing a 5G wireless network using strand-mounted small cells. It is the goal of this paper to provide a comprehensive guide for the MSOs to refer to as they move forward into expanding their respective convergence portfolios to include MVNO data offload with a strand small cell HMNO network.

THE 5G STRAND USE CASE

Many MSOs are now experiencing revenue growth and churn reduction associated with bundling mobile services with their broadband Internet offering. Since most MSOs do not own their own mobile network, they have signed MVNO contracts with Mobile Network Operators (MNOs) which gives them permission to roam onto the MNO's wireless network while offering the wireless service under the respective MSO brand.

MANY MSOS ARE NOW EXPERIENCING REVENUE GROWTH AND CHURN REDUCTION ASSOCIATED WITH BUNDLING MOBILE SERVICES WITH THEIR BROADBAND INTERNET OFFERING.

One of the biggest operational costs for MVNOs is paying for all of the gigabytes (GBs) of data that their customers are consuming on the wireless network. MSOs acting as MVNOs selling mobile services have a huge competitive advantage in that they have existing wired broadband networks. Wherever possible, MSO MVNOs are utilizing technology to off-load data traffic from their MNO roaming partner's wireless network to their HMNO network, thus significantly reducing the monthly GB data bill they have to pay the MNO. Today, Wi-Fi is used to connect their wireless customers to their HFC network today, but their plan is to use small cells to increase the amount of traffic retained on their HFC network.

MVNO DATA OFFLOAD

The majority of mobile data offload happens today in the home or office when a smartphone or tablet chooses to use a local Wi-Fi network instead of the mobile network for Internet connectivity. MSO MVNOs facilitate this action by working to ensure that their Wi-Fi networks are always available in locations where their mobile customers frequent. Wi-Fi is well suited for indoor coverage, but has limitations in an outdoor environment and many MSOs are now looking for ways to achieve data offload in outdoor locations.

One way for MSO MVNOs to achieve outdoor data offload is to deploy their own wireless network in high traffic areas where they know their wireless customers frequent.

For outdoor data off-load applications, MSO MVNOs now have the ability to deploy a new generation of small cell radios which are designed to attach to their aerial HFC

strand infrastructure, with a similar form factor as their existing nodes or elements. The new strand small cell can be powered directly from the DOCSIS network and utilize an integrated DOCSIS modem to backhaul traffic to the MSO's core network using a single cable (one bill per site attachment: power and backhaul). Similar to Wi-Fi data offload, devices are programmed to connect to the MSO's wireless signal, when available, and offload Internet traffic to that network.

The objective of the MSO is to offload outdoor wireless traffic from the MNO network to the MSO's HMNO data offload network to improve the subscriber experience through added coverage and capacity as data demand increases in outdoor wireless coverage Areas of Interest (AOIs). The following figures outline the concept of MVNO data offload in terms of typical distribution between Wi-Fi and 5G for indoor and outdoor before/after adding the MSO's HMNO/MVNO data offload network.

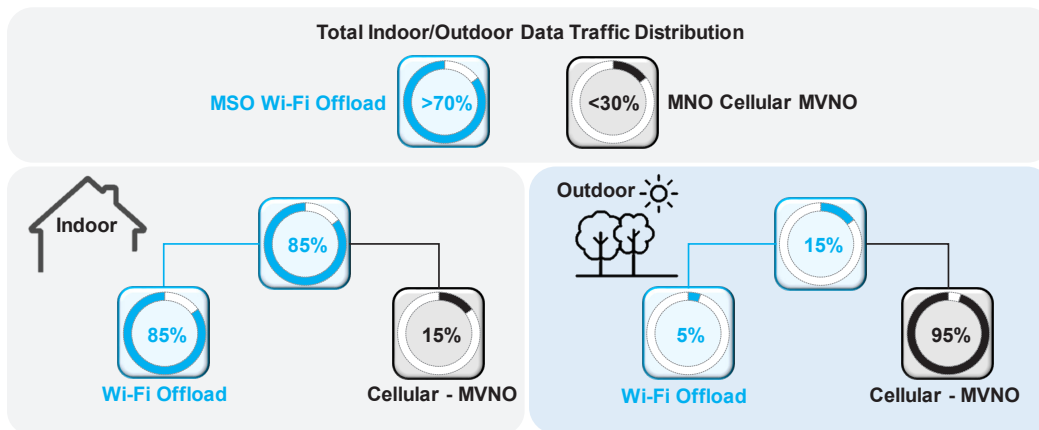

Figure 1 - MVNO Offload Distribution – Wi-Fi Offload Only

As clearly depicted in the above figure, the objective for the MSO is to offload as much outdoor wireless traffic from the MNO network to the MSO's HMNO network as possible. The following figure provides an example of how adding the CBRS strand small cell as an outdoor solution for the MSO's HMNO network can significantly increase the MVNO data offload:

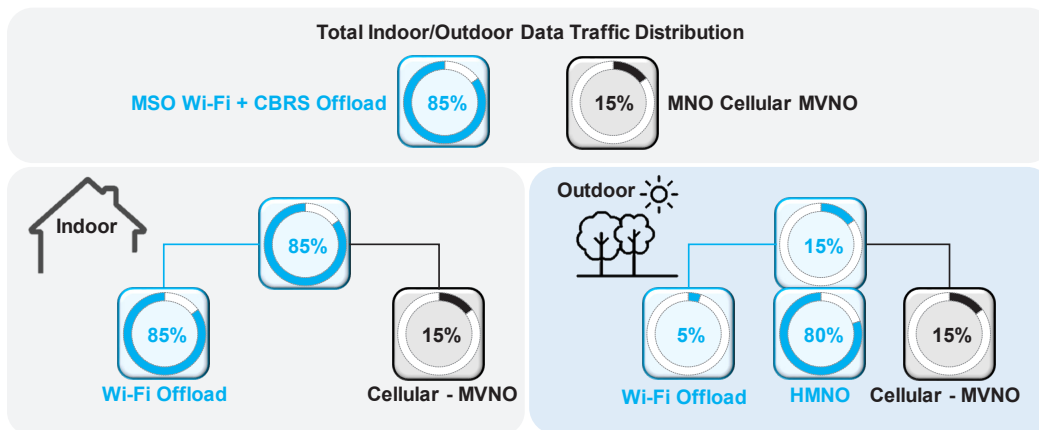

Figure 2 - MVNO Offload Distribution –With MSO CBRS HMNO Network

BUSINESS CASE

The business case for deploying CBRS small cells on the HFC network is straightforward. Strand mounted CBRS small cells create operational savings by offloading GBs of data traffic with minimal incremental investment to the MSO’s existing infrastructure while providing revenue growth and a more ‘sticky’ offering with their underlying subscriber base. Since MSO’s are deploying within their footprint, this enhances their ability to deliver mobile service to those existing customers. According to a 2020 S&P Global Market Intelligence report, “Using an existing cable network to connect wireless base stations takes one-twentieth as much time and 1% of the cost of laying down new fiber-optic cables”².

There are over 340,000 miles of accessible coax in the United States. HFC passes 96% of all US homes³. Local franchise agreements allow broadband operators to install equipment on the strand without obtaining new permits. This results in huge savings in time and expenditure, as working with the utility and going through a permitting process is typically lengthy and costly. Furthermore, battery backup provides hours of runtime during utility outages and DOCSIS 3.1 provides high speed, low-latency backhaul, that is readily available. These key factors make the strand-mount small cell business case attractive to MSOs.

The integration of the DOCSIS cable modem product with a small cell helps alleviate network congestion and provides higher capacity. It also improves data speeds with the added benefit of extending the cable network's coverage area. The combination of 5G's low latency with Cable's high-speed connectivity enhances the experience of real time services and applications. It paves the way to better supporting the growing number of Internet of Things (IoT) devices and smart technologies with diverse connectivity requirements.

TO MAXIMIZE THE MSO'S BUSINESS CASE FOR THEIR HMNO NETWORK, THE STRAND SMALL CELLS NEED TO BE STRATEGICALLY PLACED IN HIGH TRAFFIC AREAS THROUGHOUT THE TARGET MARKET.

To maximize the MSO's business case for their HMNO network, the strand small cells need to be strategically placed in high traffic areas throughout the target market. This maximizes the data traffic offloaded in the MSO's high traffic AOIs. Once fully operational, the data savings realized by the CBRS HMNO network (reduced monthly data payments to the MNO) needs to generate significant savings to total cost of deploying and operating the HMNO network.

THE HMNO NETWORK

HFC ARCHITECTURE

From a high-level perspective, the HFC architecture consists of a headend with servers and Cable Modem Termination System (CMTS). Fiber carries the signal from the headend to the optical node. Typically, the power supply sits close to the node, where the transition from fiber to coax takes place. Coax is run to what is called the "last mile," and taps take the signal to the modem inside the customer premises. RF amplifiers are also strategically designed into the network to amplify the signal. Note that the copper coax allows power to go in any direction, which provides the MSOs with the infrastructure required to support the power requirement for all active components.

Since the MSOs have HFC running to the majority of homes and businesses across the country, this allows flexibility in designing and deploying small cells into high density locations where they already have power and bandwidth available. Plant engineers can review key considerations around power budgets and RF to leverage key locations for strand mounted small cells.

The following figure summarizes the HFC network architecture with long reach over fiber and “last mile” with copper RF:

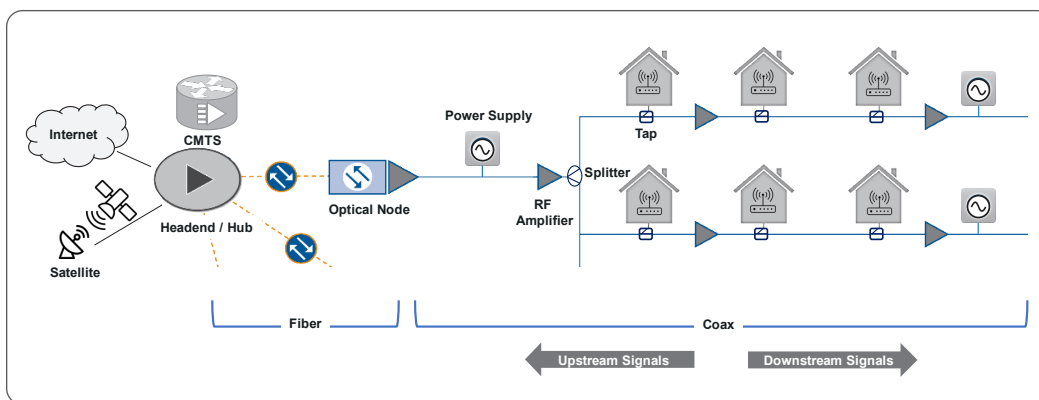

Figure 3 – HFC Network Architecture

COAX POWER DISTRIBUTION

The coaxial segment of the HFC network is also a power distribution network. The following figure outlines the distribution of broadband network power including the following key points:

- Power supplies are placed at regular intervals along the coaxial network to provide power to nodes, amplifiers, and gateways.
- Power insertion devices are used to multiplex AC power onto the same conductors carrying the RF signals.

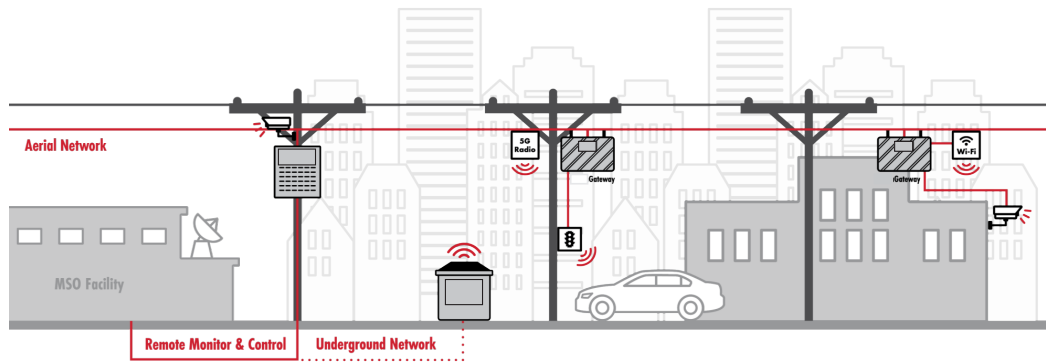

Figure 4 – Broadband Network Power - Distribution

5G CBRS HMNO ARCHITECTURE

The following figure outlines the key network components making up the 5G CBRS HMNO network⁴:

- **5G Radio Access Network (RAN)** – consisting of Next Generation Node B (gNB) radios and User Equipment (UE) wireless mobile devices,
- **5G Core** – consisting of the Access and Mobility Management Function (AMF) and User Plane Function (UPF) and the following core network functions:
 - Network Slice Selection Function (NSSF)
 - Network Exposure Function (NEF)
 - NF Repository Function (NRF)
 - Policy Control Function (PCF)
 - Unified Data Management (UDM)
 - Application Function (AF)
 - Authentication Server Function (AUSF)
 - Session Management Function (SMF)
 - Data Network (DN)
- **CBRS Spectrum Access System (SAS)** - allocates spectrum based on availability and Tier 1, 2, and 3 prioritizations:

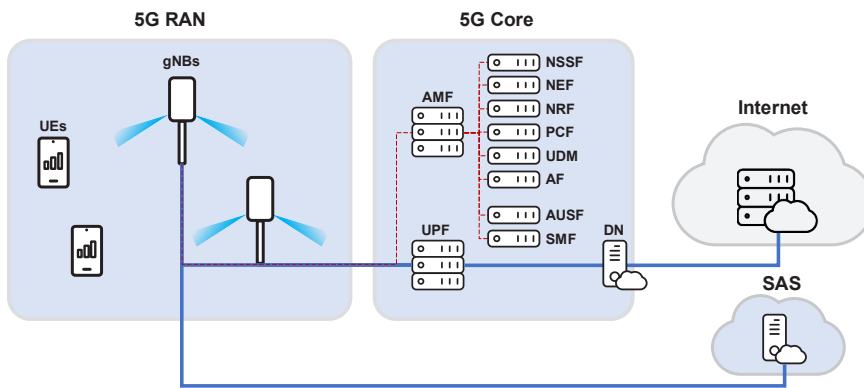

Figure 5 – 5G CBRS Network Architecture

HMNO DSDDS DEVICE CAPABILITY

As an integral part of the MVNO data offload ecosystem, end-user devices should support seamless switching between the MSO/HMNO and the MVNO networks. The most commonly used switching technology is Dual SIM Dual Standby (DSDDS). In particular, the DSDDS functionality manages the subscriber data access to the available wireless networks automatically. This is similar to how Wi-Fi offload works today, where the mobile device will automatically connect to the available Wi-Fi signal and route data traffic over Wi-Fi and save the subscriber from paying for data over the wireless network. This customized DSDDS functionality allows the mobile device to manage the data offload preference to favor either the MSO’s HMNO network (when available) or “fall back” to the MNO’s network in case the MSO’s HMNO network is unavailable or an unsupported service (e.g. voice) is required. The following figure summarizes the DSDDS functionality required for the UE part of the MSO’s HMNO network ecosystem to operate effectively:

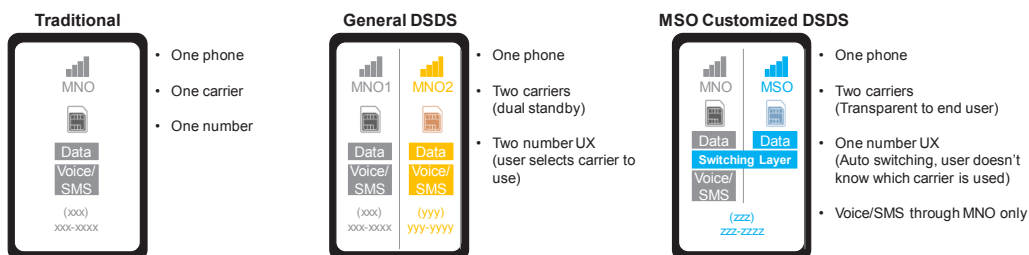

Figure 6 – MNO to MSO MVNO Data Offload – DSDDS

WIRELESS SPECTRUM AND DOCSIS

When considering the technology and architecture of an HMNO network, the MSO needs to decide on the wireless access spectrum for subscribers to connect their mobile devices to the wireless network. Additionally, the MSO will leverage their DOCSIS infrastructure to provide backhaul for the wireless HMNO network. This will be routed to the Internet and will provide a transparent service experience to the MSO's mobile subscribers. At the time of the writing of this paper, the following sections outline the current and future wireless spectrum and DOCSIS technologies available for the MSO to support an MVNO data offload ecosystem on their respective HFC network.

CBRS SPECTRUM BAND

CBRS (operating from 3550-3700 MHz) is recommended for the MSO's MVNO data offload network due to device availability/network ecosystem maturity, and economies of scale/cost of device and network infrastructure.

CBRS BACKGROUND

The following provides some background on CBRS spectrum:

- The FCC designated the CBRS band to operate in shared spectrum spanning 3550-3700 MHz and, together with the OnGo Alliance⁵ and WInnForum⁶, established a product certification program for CBRS equipment and support the coexistence of Citizens Broadband Radio Service Devices (CBSDs). A CBSD is any wireless device that operates on CBRS spectrum. The 5G strand small cell referenced in this paper is classified as a CBSD.
- The 3rd Generation Partnership Project (3GPP) ⁷ standards body defined band 48 for CBRS spectrum using 3GPP air interface technologies.
 - NOTE: When referencing 3GPP air interface standards in CBRS spectrum, "Band 48" or B48 refers to 4G/Long Term Evolution (LTE) while n48 refers to 5G/New Radio (NR).
- Both B48 (LTE) and n48 (NR) air interface are based on shared DL and UL Time Division Duplexing (TDD) channels/carriers that adhere to the 3GPP standard implementations of Orthogonal Frequency-Division Multiplexing (OFDM) Modulation Coding Schemes (MCSs).

- CBRS spectrum allocation to wireless operators is managed through a SAS provided by a third-party independent company.
- The SAS will “grant” access to blocks of CBRS spectrum (via channel grants) in increments of 5 and 10 MHz bandwidth; up to 40 MHz of Priority Access License (PAL) channels and up to the full 150 MHz of General Authorized Access (GAA) channels.
- In 2020, the FCC held Auction 105 which made available PALs in the lower 100 MHz (3550-3650 MHz) portion of the CBRS wireless access spectrum:
 - Many MSOs won PAL licenses through the CBRS auction which has an evolved ecosystem that supports the MSO’s MVNO data offload ecosystem with DSDS devices.

The following figure summarizes the CBRS spectrum and how it is shared and allocated across the 3550-3700 MHz range:

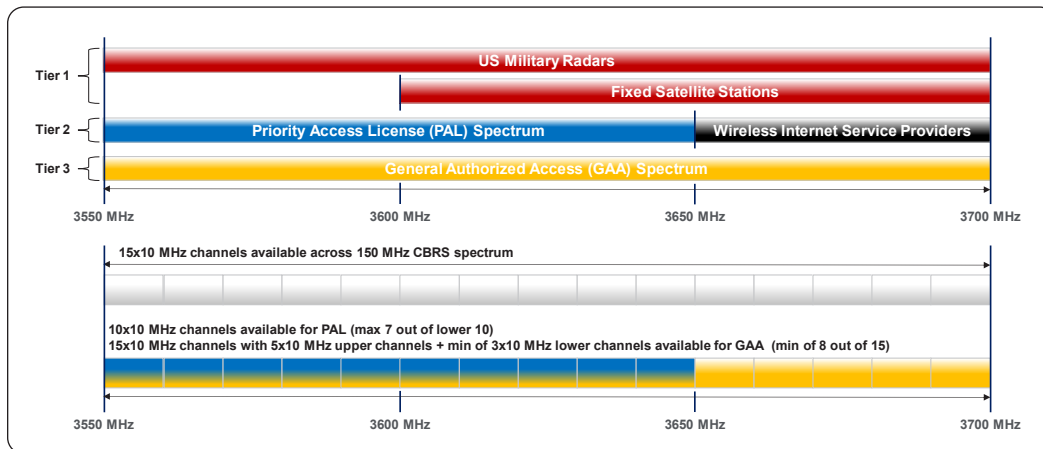

Figure 7 – CBRS Wireless Spectrum

Note that Tier 1, Tier 2 – PAL, and GAA spectrum all overlap. So long as the CBRS spectrum is available with no Tier 1 or Tier 2 spectrum allocations, the CBRS spectrum is available as GAA spectrum allocation.

CBRS AIR INTERFACE

The following lists the main RF characteristics (Modulation, Numerology, Bandwidth, Carrier Aggregation (CA)) of the CBRS n48 air interface:

- The downlink and uplink use OFDM modulation in a shared Time Division Duplex (TDD) channel.
- The MCS ranges from Quadrature Phase Shift Keying (QPSK) to 256 Quadrature Amplitude Modulation (QAM) constellations. QPSK provides high Forward Error Correction (FEC) for robust signaling and low throughput applications (especially on the uplink) while 256 QAM provides the opportunity to offer high throughput to users on the downlink channel.
- The numerology or Sub Carrier Spacing (SCS) can either be 15 or 30 kHz.
- The channel/carrier bandwidth can be 5, 10, 15, 20, 30, 40, 50, 60, 70, 80, 90, or 100 MHz with typical values highlighted in bold.
- Supports stand-alone operations with intra-CBRS band Carrier Aggregation (CA).
- Can also support additional band combinations with CA anchored to other licensed FDD and TDD bands (e.g. when connected to MNO networks).

As mentioned previously, the CBRS band is a shared spectrum band. There is no guarantee that, at any given point in time, large contiguous blocks of spectrum will be available for use. Note that the SAS will dynamically assign actual CBRS PAL and GAA channels based on priority and availability of channels. Therefore, the carrier aggregation capabilities of both the small cell and the end user devices (in particular, support for non-contiguous Carrier Aggregation) should be considered.

The following figure depicts three different examples of channel bandwidth and Component Carrier (CC) and Carrier Aggregation (CA) combinations:

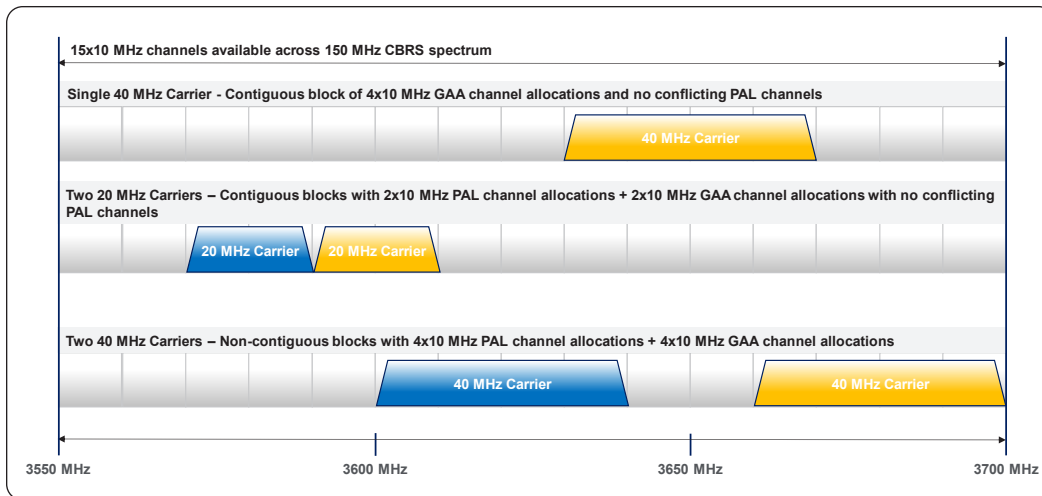

Figure 8 – CBRS Channel Bandwidth, Component Carriers, and Carrier Aggregation

Note that the first example consists of a single CC while the second and third examples consist of two CCs. Three or more CCs may also be assigned based on the capabilities of the gNB and UE. These may either allocate carrier bandwidth to the UEs as separate channels, or allocate paired channels in CA mode for those UEs that support CA. These UEs can take advantage of combining the two carrier bandwidths into one data stream. With reference to the above figure, the following lists three key small cell specifications:

- Operating Frequency Range (OFR) – This is the full range of frequencies which the small cell can operate. In the case of CBRS, the OFR would be 3550-3700 MHz.
- Occupied Bandwidth (OBW) – This is the total carrier bandwidth which the small cell can transmit at any given time. In the above three examples in Figure 8, the OBW would be 40, 40, and 80 MHz, respectively.
- Instantaneous Bandwidth (IBW) – This is the maximum frequency spread/separation (lower most to upper most) that the small cell can transmit simultaneously. In all cases for CBRS small cells, the IBW should be the full 150 MHz so it can support transmitting on the lower most (3550-3560 MHz) to the upper most (3690-3700 MHz) CBRS channels at the same time.

OTHER SPECTRUM BANDS

The MSOs may continue to evaluate new unlicensed, licensed, or shared/managed spectrum bands:

- Additional spectrum bands may become feasible to add to the MSO's MVNO data offload portfolio (i.e. low-band/below CBRS, sub-6 GHz, mmWave, etc.) which can provide additional overlay/underlay coverage and capacity layers. The availability of these bands will depend on the maturity of the device and network ecosystem (roadmaps), economies of scale (cost of devices), and available network infrastructure to support these additional spectrum bands.
- In terms of 3GPP nomenclature, Frequency Range 1 (FR1) refers to frequency bands operating below 6 GHz while FR2 refers to frequency bands operating above 6 GHz. An example of FR2 would be mmWave spectrum which operates in bands above 28 GHz with the lower unlicensed part of n260 (37.0-37.6 GHz portion of the 37.0-40.0 GHz band) as a future possibility.

DOCSIS

The DOCSIS HFC channel line ups are broken into three groups of frequency specific allotments:

- **Forward** – RF spectrum assigned to deliver downstream traffic from the DOCSIS core to the Customer Premises Equipment (CPE).
- **Return** – RF spectrum assigned to deliver upstream traffic from the CPE to the DOCSIS core.
- **Power** – 50 to 60Hz AC power traverses the coaxial cable plant.

The current DOCSIS 3.1 cable plant utilizes 50-60 Hz for the power path. In DOCSIS 3.1, there is a variation between low, mid, and high-split frequencies which are configured based on the upstream data path, summarized as follows:

- Low split is typically 5-42/45 MHz
- Mid split is typically 5-85 MHz
- High split is typically 5-204 MHz

These splits allow upstream throughputs of up to 108 Mbps, 216 Mbps, and 1 Gbps, respectively.

Bonded Single-Carrier Quadrature Amplitude Modulation (SC-QAM) provides 2 or 4 times the upstream capacity, while full Orthogonal Frequency Division Multiple Access (OFDMA) configurations can further increase upstream capacity by 2 times. Corresponding downstream frequency ranges are typically configured from 108-1002 MHz or 258-1218 MHz.

The maximum downstream capacity is 10 Gbps but the current DOCSIS modem hardware utilized in strand small cells limits that speed to 1 Gbps.

MSOs have an advanced DOCSIS network that they've honed over many years to effectively bring high speed internet to consumers. This same network can be utilized for backhaul of small cells. The exciting new advancements in DOCSIS around low-latency active queue management, low latency backhaul, DOCSIS 4.0 extended spectrum Frequency Division Duplexing (FDD), and Full Duplex DOCSIS (FDX) bring further enhancements to support the next generation of wireless.

5G STRAND SMALL CELL ENGINEERING

Developing an integrated 5G strand small cell is a complex engineering challenge. There are many design variables that should be considered, (which often compete with each other), in order to develop the optimum and balanced solution.

Everything from physical characteristics and environmental considerations through power, DOCSIS, and antenna design need to be integrated into a compact package that must pass rigorous certification processes (SCTE DOCSIS 3.1/CableLabs⁸, FCC⁹, and UL¹⁰ to name a few). Once these certifications are completed, the small cell can be confidently deployed into the MSOs HFC network for commercial use.

In particular, the integration of the DOCSIS CM into the small cell requires close collaboration between respective engineering teams (i.e. software and firmware considerations around RF immunity and emissions, heat dissipation, and MSO parametric, outside plant, and DOCSIS requirements). It takes extensive technical expertise and teamwork to make this integration successful.

FORM FACTOR - PHYSICAL CHARACTERISTICS

Since the 5G small cell will be mounted on the aerial HFC cable strand, the following key physical characteristics need to be considered:

- **Size** – Must meet requirements for the communications space. Must be short and narrow enough to provide clearance to main strand cable bundle above and telco cable level below and have a small enough cross section to minimize the impact of wind loading.
- **Weight** – Must be light enough for the outside plant (OSP) team to install and maintain. When installed, the small cell must be within the cable tension weight tolerances, including wind loading.
- **Mounting brackets** – Must be strong enough to handle the load but also be adjustable enough to compensate for small cable sag angles to keep the strand level. Adequate clearance to the main strand cable bundle above and also the telco cable below must be maintained to avoid the possibility of chafing when the strand is swaying in the wind.
- **Appearance** – Should appear similar to existing HFC strand mounted hardware (such as fiber nodes and amplifiers), to be consistent with HFC outside plant devices.
- **Pest resistance** – Must avoid “sheltered pockets” and exposed cables where pests can build nests or chew cables. This event could impact the network performance either directly or indirectly as a result of compromised heat dissipation.
- **GPS Mounting** – Must be mounted clear of main strand bundle and meet Environmental Considerations listed below.
- **Additional requirements** – Must meet MSO-specific requirements (e.g. connector types, installation guides, local, state, and federal laws and regulations, etc.):
 - Physical distance for service personnel can be maintained so climbing space and RF radiation distances are easily met as the small cells can be mounted away from the pole and other serviceable components.
 - Disconnect switches can be placed in the power path of the small cell to allow easy service shutdown in case of maintenance activities.

The following figure outlines the generic Strand Small Cell Dimensions and Cable clearance and spacing requirements as per N.E.S.C. Rule 235H¹¹:

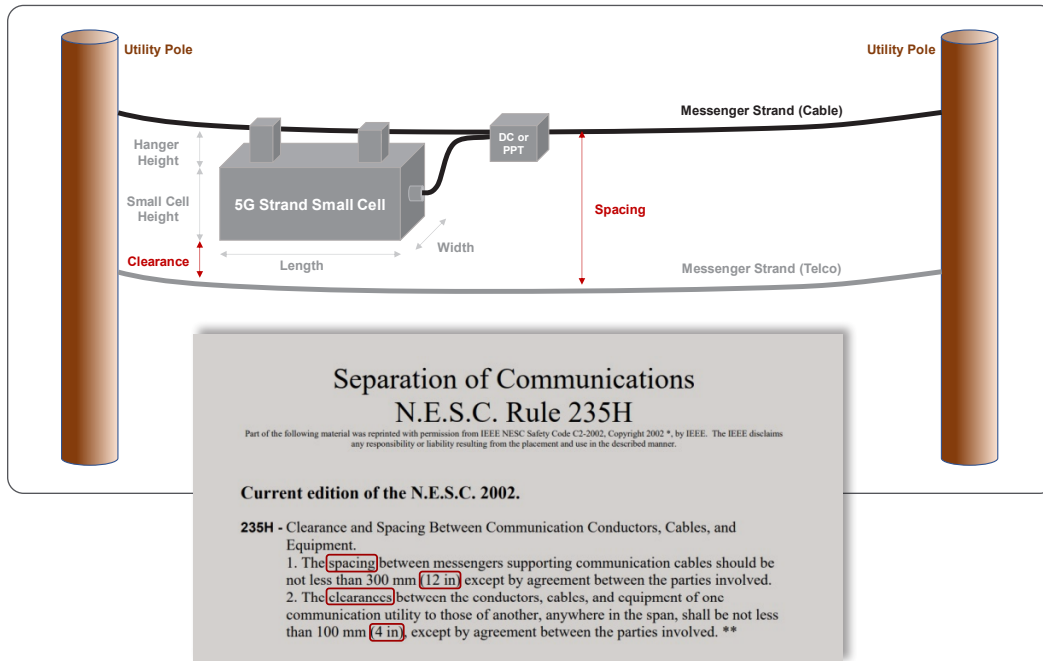

Figure 9 – Strand Small Cell Dimensions and Cable Clearance

ANTENNA CONSIDERATIONS

The following key considerations apply to the installation planning and deployment of strand-mounted small cells on the MSO's plant infrastructure:

- **Antenna size** – The size of a wireless antenna is determined by two basic factors: wavelength and gain. The CBRS frequency band at 3.55 GHz has a calculated estimated wavelength of ~3.33'. This small size makes CBRS frequency ideal for supporting higher gain antennas in a small form factor that will fit within the same clearance requirements as any strand-mounted/aerial DOCSIS hardware.
- **Mechanical** – The antennas used for the strand-mounted small cell chassis would be secure, IP67 rated connections and have a radome that protects the antenna elements from dust, water, vibration and shock/impact while being "electrically transparent" so as to not adversely affect the antenna pattern and gain.

The following figure depicts a generic representation of the key physical characteristics (i.e. dimensional considerations) for a simplified single integrated antenna panel/radome. In this example, the antenna panel is mounted on one face of a strand small cell. Note that, depending on the desired electrical characteristics for the strand small cell (i.e. sector/omni, gain, beamwidth, etc.), multiple antenna panels may be mounted at different locations around the strand possibly combined into one or more “antenna arrays” that would provide omni or sector antenna configurations:

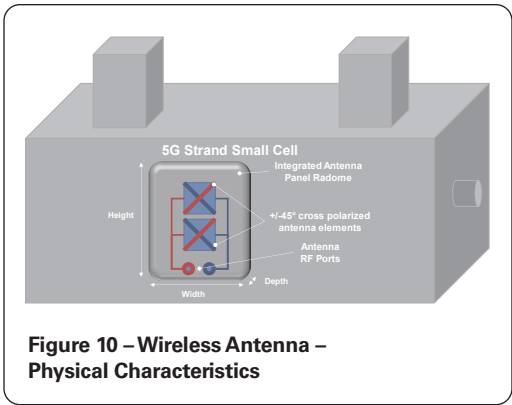

Figure 10 – Wireless Antenna – Physical Characteristics

Another aspect to consider is the mechanical tilting of the strand-mounted small cell. This scenario is depicted in the figure below. Specifically, if the MSO’s messenger strand is sagging on a steep enough incline such that the strand small cell “leveling” brackets cannot compensate to make the small cell level (also due to requirement to maintain correct clearance to the telco messenger strand, there will be a forced mechanical tilt such that there will be an “up-tilt” in the direction of the incline, and there will be a steeper “down-tilt” in the downward slope. This will result in the coverage being skewed in both directions, depending on the clutter and obstacles in the horizontal plane. This should be considered during RF network planning in order to select mounting locations that avoid this this scenario.

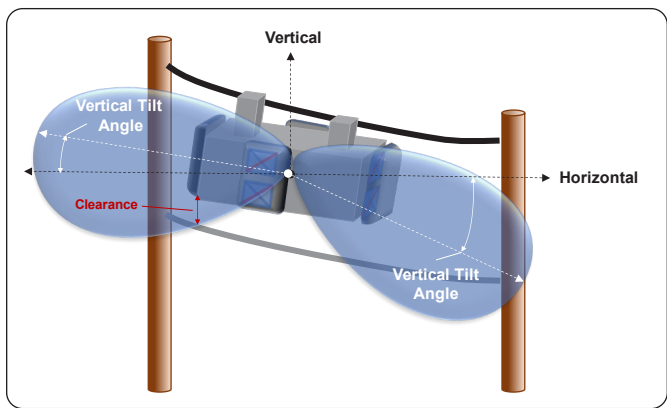

Figure 11 – Mechanical Tilt - Omni Strand Antenna

ENVIRONMENTAL CONSIDERATIONS

The following key environmental considerations must be factored into the design of the outdoor strand-mounted small cell exposed to the elements to maintain high reliability/availability (minimize aging):

- **Heat dissipation** – Must passively dissipate heat at a sufficient rate to regulate the inside temperature of the small cell so the unit does not fail or negatively impact the HFC network, even at high outdoor temperatures (e.g. +55°C).
- **Cold start** – Must boot up and reliably operate following power outage at below freezing temperatures (typically -40°C).
- **IP67** – Must provide 100% ingress protection from dust and water (i.e. salt fog, acid rain tolerance, UV suitability, resistance to infestation).

The following figure depicts the strand small cell internal components that, depending on loading, will impact the internal temperature and required passive heat dissipation to maintain reliable operations across the external temperature range of -40 to +55°C:

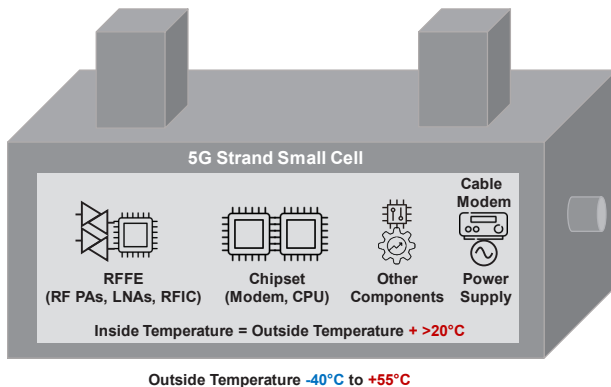

Figure 12 – Strand Small Cell Heat and Loading

POWER AND DOCSIS

Power is one of the most important design factors for a small cell since it impacts all the key attributes and capabilities of the unit. The small cell with integrated DOCSIS is drawing its power from the existing coax cable plant and should be designed to optimize power consumption while achieving maximum radio performance. One needs to factor

POWER IS ONE OF THE MOST IMPORTANT DESIGN FACTORS FOR A SMALL CELL SINCE IT IMPACTS ALL THE KEY ATTRIBUTES AND CAPABILITIES OF THE UNIT.

in the HFC architecture and various plant considerations to operate within the capabilities and tolerances of the existing infrastructure, to avoid negatively impacting the primary broadband performance, operations, and business model. This is a key consideration to the MSO outside plant team.

Cable broadband power supplies deliver AC power from a utility connection to coaxial cables to power active network elements. This power is typically generated at 90-volts AC in a quasi-square wave form. This network was purposefully designed 40+ years

ago so that a licensed electrician was not required, and a low-voltage technician could work on them. A ferro-resonant transformer provides the foundation to the power supply and prevents many disruptions to the network. Often this network is also backed up by batteries that store energy in the event of a utility outage. This makes the HFC network power much more reliable than utility power.

The small cell and all active gear in the HFC plant must be engineered to operate down to 45-volts AC to allow for plant losses. Based upon Ohm's law, the total voltage will decline with resistance as you get further away from the power supply source. Power will also be pulled from the active gear in the upstream coaxial path. The primary point is, based upon how the network is engineered, there is typically a lot of flexibility in where to place the small cell for each individual section of the plant.

The power supply board embedded in the small cell must convert the quasi-square AC power to DC power that can be used by the active components (including the cable modem). Most power supply boards that are used today are based on a switched-mode design. A switched-mode power supply maintains a constant power over a specified input voltage range of the HFC network (45-90 VAC), meaning that as the incoming voltage drops the current pulled will increase.

BROADBAND NETWORK POWER

There are several advantages to the HFC network power over direct utility power. The first is the simplicity of working with a single vendor; the cable operator. You also don't have to install a meter, wait on additional scheduling, or pay an additional bill. Another advantage

is the voltage used in a cable plant complies with the NESC 90 VAC low-voltage standard. This eliminates the requirement for a licensed electrician for the installation.

The design of modern HFC powering systems implement a ferro-resonant transformer with a capacitor tank circuit that provides up to 30 dB of isolation from transient energy events, commonly experienced on direct utility power. Another huge advantage is the ability to connect the power (and communications backhaul) from a single waterproof connection. This may be a hardline or drop cable; the single cable carries all the necessary components to facilitate the connection. Finally, the fact that almost all HFC cable plants in North America leverage a battery backup which provide uninterrupted power over several hours to days without utility connection.

The following figure outlines the main components of broadband network power:

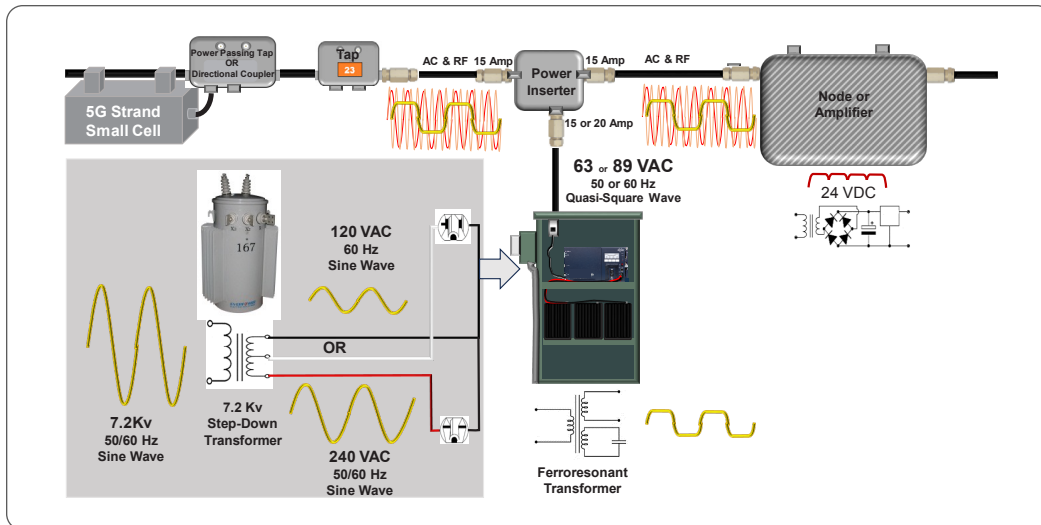

Figure 13 – Broadband Network Power - Overview

RF / PLANT CONSIDERATIONS

Deployment of RF transmitters and receivers of any kind close to a cable network can be challenging. In the past, any customer who placed their 4G/LTE phone next to a cable box can attest that a high-power transmitter impacts the quality of RF signals.

TESTING STANDARDS

The SCTE is aware of these situations and has developed many qualification specifications around the cable connected devices to improve the robustness of the DOCSIS network against 4G and 5G wireless networks. As part of this, testing standards have been developed for both, creation of interference to the cable plant, as well as tolerance to interference on the cable plant.

One such standard is the SCTE 40 Digital Cable Network Interface Standard¹² which defines survivability testing and criteria for cable connected equipment. There is also a testing standard for shielding effectiveness. ANSI/SCTE 48-1 2021¹³ provides a test method for shielding effectiveness of passives and actives using a Giga Transverse ElectroMagnetic (GTEM) Cell.

There are SCTE LTE field testing recommendations from the SCTE 201 2020 showing how much the potential impact of LTE is considered in cable systems (note that 5G/ NR has essentially the same interference characteristics of 4G/LTE since they both use the same OFDM air interface). Even so, there are additional considerations when placing a >5 W radio next to a hardline or drop cable.

RF ISOLATION

During installation, it is important not to cross the small cell antenna with a drop cable; even quad-shield cable can allow enough energy to propagate to interfere with SC-QAM and OFDM channels. Isolation is an important factor in deploying services. The cable architecture is inherently designed to be isolated from interference, while small cell communications is inherently design to effectively manage wireless interference. However, a potential issue arises when a high-power source is placed close to a point of an ingress to either the cable network or small cell. For example, >5 W of wireless radiated RF signal is significantly higher than the SC-QAM channels running at +40 dBmV in the cable RF signal. Additionally, QAM channels running at +40 dBmV are also much higher than the small cell receiver RF signal levels expected from received handset power levels in the uW range.

DIPLEXING

The cable system has evolved over the years, starting with a simple antenna distribution system to today's networks running multiple split, 2-way plant with distributed CMTS architectures leveraging Converged Cable Access Platform (CCAP) remote Physical (PHY) and remote Media Access Control (MAC) PHY fiber-deep deployments. The DOCSIS 3.1 modem hardware is designed to support the OSP evolution with software adjustable attenuators and electronic multiband diplexers.

The DOCSIS 3.1 CM installed into the strand small cell contain diplexers which isolate and direct the downstream and upstream RF signals. It is extremely important that the CM diplexers support the specific network they will be installed into. As outlined earlier in Section 2.2.2 above, MSOs use different "low", "mid", and "high" frequency splits, summarized as follows:

- Current Mid-split modems typically use upstream frequencies of either 5-42 MHz or 5-85 MHz with downstream frequencies of 108-1002 MHz
- Current High split modems typically use upstream frequencies of either 5-45 MHz or 5-204 MHz with downstream frequencies of 258-1218 MHz

The diplexer frequency ranges are set using the DOCSIS standard leveraging MAC Domain Descriptor (MDD) and type, length, value (TLV) 84 (configuration state of the RF plant) messages sent by the CMTS. Certified DOCSIS modems respond to this command and set their RF front end appropriately.

The following figure summarizes the current (DOCSIS 3.1) and future (DOCSIS 4.0) diplexing splits and upstream data limits:

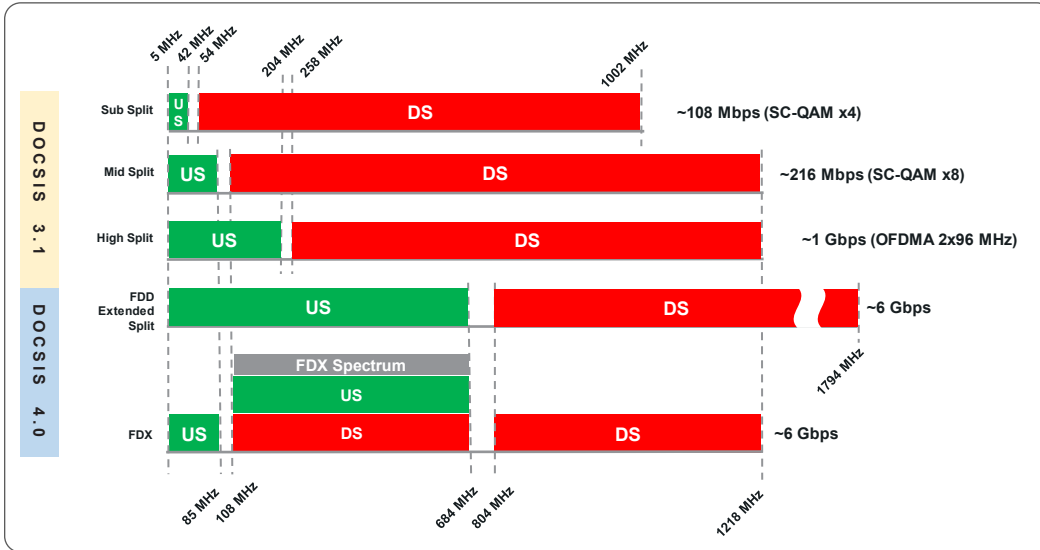

Figure 14 – DOCSIS - Diplex Splits & Upstream Data Limits

POWER

All but the oldest of these networks leverage an integrated power delivery system used today to provide power to all the HFC equipment. Passive components allow existing HFC deployments to support fiber deep without having to change the existing power infrastructure. Fiber deep architectures, much like small cell, leverage the concept of densification providing additional launch points to improve deployed throughput.

An evolution has occurred over the last decade as improvements in amplifier silicon GASFET and enhancements in the efficiency active power pack supplies used in the HFC equipment has reduced power consumption. However, the deployment of more sophisticated field devices with multiple node points in a single module and the reallocation of the CMTS components to the field have increased power demands. The active field power packs today are mostly based on switch mode designs which vary their current demand as the plant voltage changes to retain constant power. The cable companies understand these variabilities and have dictated that field equipment must operate between 45 VAC and 90 VAC to better control the expected current demands while allowing the expected plant passive losses to allow substantial cable lengths.

The power budget changes over the day and year based on the passive resistance changes due to temperature. As with most wire and electronics, increases in temperature increase passive losses. Leaving headroom in the power budget is critical in assuring reliable plant operation.

Adding equipment like strand-mounted small cells impacts the existing power budgets. Even though HFC power supplies can run close to their rated power indefinitely, both the supplies and cable architecture are more reliable if there is some headroom left for their operation. The important item in adding any of these components is that their impact is more than just their advertised power consumption. The passive loss will impact the voltage of this and all the other actives on the HFC leg, increasing their current demands as well. Therefore, adding a strand small cell device that consumes 95 W at the end of the line (e.g. at 55 VAC), would create a 1.7 AAC draw. Depending on the length of cable, the input voltage could drop the voltage to 47 VAC, increasing its demands to 2 AAC. This would also drop the voltage to all other actives with any cable passive loss, creating an increase in plant current demand.

Most HFC hardline components are designed to operate with up to 15 AAC, with the power supplies themselves operating from 5 AAC to 24 AAC. When adding additional load, through the addition of small cells, upgrading the power system is possible, up to the point you reach the passive current capability. A 15 to 18 A power supply on a single circuit is about as high as possible without having to split the powering to 2 separate circuits. The recommended course of action when reaching close to 15 A load is to upgrade power supplies and/or splitting the demand using additional power sources as required. Additional power delivery improvements can be obtained by the proper use of power feeder cable, with its lower loop resistance.

Today's cable operators are continuously aware of the power demand on their plant through the use of power monitoring systems in each powering location. The powering devices with their embedded cable modems leverage the same DOCSIS networks to immediately notify Network Operation Centers (NOCs) of any change in the utility or HFC powering parameters.

DIRECTIONAL COUPLERS AND POWER PASSING TAPS

MSO outside plant teams are familiar with using both directional couplers (DCs) and power passing taps (PPTs). They will consider site location, power budget, and existing plant design to determine when to use a DC or PPT to install the small cell.

DIRECTIONAL COUPLERS

Hardline Directional Couplers (DCs) are devices that allow for a percentage of RF power and the AC power line to be coupled to another leg or device on the plant. Their use requires equipment capable of handling 15 A of power, though a pin to F or BAFF¹⁴ connector can allow the use of an F connector, if desired. There are many “Mini Macro” small cell deployments that leverage a DC. Those deployments use larger radios which could pull up to 300 W. The hardline connections used with DCs require the same level of complexity as anything else in the hardline architecture. Large tools like coring tools and wrenches are required in their installation. The forming of the hardline to the KS connections is also labor intensive. Finally, removing or replacing a connected device can be time consuming.

Installation of a DC normally requires cutting of the existing hardline, which may mean the shutdown of the power system to avoid shorts. The DC installation time is minutes to hours as all connections should be complete before restoring AC to the HFC plant.

The following figure depicts the use of DCs to power stand-mounted small cells:

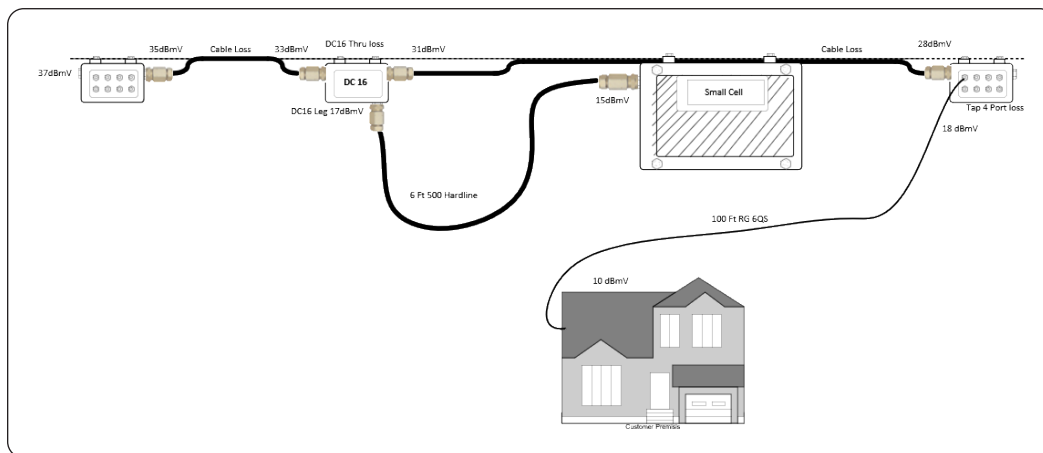

Figure 15 – Directional Couplers for Small Cells

POWER PASSING TAPS

Power passing taps (PPTs) are another common form of small cell connection to a cable plant. These devices enable the conversion of hardline to drop cable (typically RG 6QS) but are limited to 2 AAC or less. This is well within the 5 A current capability of RG 6 cable and F connectors, but limits the small cell to a 95 W ($45 \text{ VAC} \times 2 \text{ AAC}$) load and further limits their transmitters to that load.

Note that MSOs need to budget power distribution available to each strand small cell. Therefore, strand small cells connected to power passing taps typically operate below the maximum allowable Category B CBRS EIRP limitations (i.e. EIRPs of $< 47 \text{ dBm}/10 \text{ MHz}$). However, deployments using power passing taps are quicker and less labor intensive than the hardline DC installations:

- In most cases, an existing tap location is leveraged as the system can run up to 100' of drop cable to the small cell.
- These existing tap faces are replaced with a power passing tap.
- The power passing shunts are installed to allow power to the port where the small cells will be connected, and the drop cable is connected to the small cell.
- The last part of installation is to connect the drop cable to the power passing tap port to assure the center conductor does not short to the body or F connector.
- The shunts may also be placed after the connection is made, but that is not typical.

Interruption in the HFC plant power and RF may only be experienced as the tap face is replaced, normally only a few seconds to minutes.

In both cases, the passive and actives of the cable plant are populated to pass AC to the point the small cell makes connection. This may require opening the field devices and installing shunts.

The following figure depicts the use of PPTs to power stand-mounted small cells:

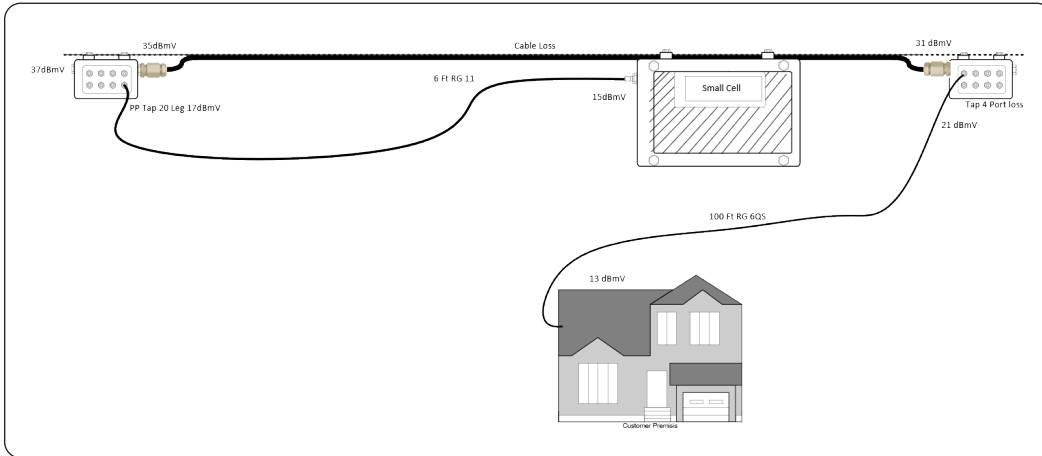

Figure 16 – Power Passing Taps for Small Cells

DIRECTIONAL COUPLER AND POWER PASSING TAP COMPARISSON

The following table summarizes and compares the key considerations when designing and implementing the DC and PPT power distribution for strand-mounted small cells:

Table 1 – Directional Coupler and Power Passing Tap Considerations

Consideration	Directional Coupler	Power Passing Tap
HFC Components	DC, 1 to 2 Hardline adapters, Heat Shrink	Power Passing Tap Face
HFC Time	30 min to over 1 hour	5 to 15 min
DS RF Plant impacts	2 to 4 dB	0 dB
Potential DS changes	up to 30 additional minutes	0 minutes
HFC power	up to 300W	<100W
HFC Engineering Required	Typical, power, data, RF DS affects may have to be addressed US and DS.	Little, mostly power, data
Drop Cable to Small Cell	420 – 500 hardline, 2 hardline adapters, coring, assembly and heat shrink	RG 6 or RG 11 - Crimp

DOCSIS BACKHAUL

MSO's can leverage their HFC network for supplying both power and backhaul on a single cable to the small cells that comprise the HMNO network. Integrating a DOCSIS CM into the small cell provides the backhaul while integrating a switched-mode power supply will enable the small cell to draw power from the DOCSIS plant via the cable connected to the DOCSIS CM port.

Currently the DOCSIS 3.1 CM is the mainstream standard for backhaul with available throughput of 1 Gbps downstream and 1 Gbps upstream. Next generation DOCSIS 3.1 solutions will add available throughput to achieve up to 2.5 Gbps downstream. As MSOs upgrade their HFC networks to the new DOCSIS 4.0 standard with new splits, the legacy DOCSIS 3.1 CMs can still be supported while new/upgraded strand small cell variants could be added with the improved throughput and features that DOCSIS 4.0 provides.

Since the small cell shares the DOCSIS network with personal and business broadband subscribers, considerations should be made when dimensioning the number of node-splits and devices per cable run. Specifically, the added DL and UL requirements for the strand small cell will require new DOCSIS dimensioning rules to protect existing users while increasing service levels and also ensuring enough bandwidth is allocated. Allocation is based on both the broadband and wireless traffic models (e.g. busy hour (BH)) and utilization for personal, business, and MVNO data offload.

FIRMWARE CONSIDERATIONS

Integrating a DOCSIS CM with a small cell comes with unique challenges. Merging two distinct technologies and interoperability testing (IOT) requires complex engineering knowledge of both technologies. The following summarizes the main considerations:

- Event driven actions that signify when systems go up/down (for example, transferring knowledge from the cable modem to the small cell as to when the modem has either rebooted or lost and re-gained the DOCSIS link).
- The need to maintain backhaul capacity and reliability, including high throughput and low latency. This requires fine tuning of the DOCSIS channels, combined with modifications to modulation profiles and management between the headend CMTS and the CM to ensure that data is sent upstream/downstream in a timely manner required to maintain the wireless network.
- The cable modem software undergoes routine updates as updated requirements from various MSOs arise. This is further necessitated by the continuous forward progress and improvements from the DOCSIS eco-system. Different firmware versions across the same product line can cause variations in the behavior and incremental firmware versions need to be managed to ensure consistent and aligned firmware interoperability between the CMTS, CM, and small cell.

- The DOCSIS architecture leveraged in this solution provides a secure method of updating the DOCSIS cable modems using the “private” cable modem space. All the firmware images are keyed using a manufacturer CVC or CVC chain which should both match the target modem and the firmware file to be applied. The cable operator can further secure the deployment of firmware by requiring a cosigned image so any unapproved firmware would be ignored by the small cell cable modem.
- An integrated CM and small cell enables the possibility of establishing a common protocol between the 2 different platforms. They may share an integrated controller (I2C) channel which can aid with relaying messages, diagnostics, and/or initiating state changes (e.g. reboot or re-initialization of the various Open Systems Interconnection (OSI) layers depending on internal diagnostics).

ANTENNAS

The antennas used for the strand small cell are an essential component of the overall system design as they define the coverage area for each deployed strand small cell and therefore, directly impact the site density, power and backhaul distribution, and resulting business case for the MVNO data offload deployment.

OMNI AND SECTOR

There are two fundamental antenna array configurations for strand small cells; omni and sector. Greenfield deployments of cellular networks often start with omni configurations since they provide simplicity with planning and focus on the initial goal of coverage. As the networks mature and require additional capacity, sector configurations can automatically double the data offload in high-density AOIs. As part of the planning, deployment, and operations of an MSO’s HMNO network, the MSO should consider both omni and sector configurations to balance the operational simplicity of omni with the capacity benefits of sector antenna configurations. The following table summarizes the considerations between omni and sector antenna configurations:

Table 2 – Omni and Sector Antenna Considerations

Consideration	Omni	Sector
Form Factor	Antennas need to consider the physical and electrical obstruction of the strand small cell chassis (i.e. near field effects that impact resulting pattern)	Antennas can face outwards, away from the strand small cell chassis with minimum impacts of near field effects that cause ripple and nulls in antenna pattern
Coverage	1 sector per small cell, covering all directions	2 or more sectors per small cell with overlapping zones to support handovers between adjacent sectors
Capacity	1 cell capacity for all mobile users in shared geographic coverage area of the small cell	2 or more geographic zones, each with 1 cell capacity so total small cell can support up to double the capacity, depending on the geographic split of mobile users across each zone's coverage area
Planning	Simplified planning and deployment since no antenna azimuth	More complex planning since strand small cell orientation needs to consider the azimuth orientations of the antenna sectors
Optimization	Limited flexibility for changing coverage with main "adjustment knob" being changing RF power levels	More flexibility for changing coverage since have 2 or more RF power levels to adjust

For comparison, the following figure depicts representative horizontal antenna patterns for generic Omni and 2-sector antenna arrays:

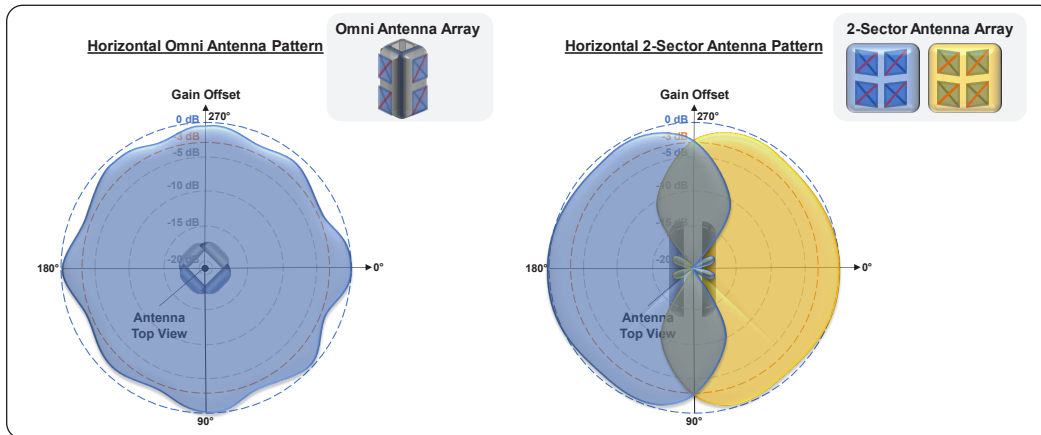

Figure 17 – Wireless Antenna – Omni and Sector

ELECTRICAL CHARACTERISTICS

In order to facilitate reliable coverage and high user throughput (both on the downlink (DL) and the uplink (UL)), the small cell antenna system need to consider the following key factors:

- **Gain** – Provide enough RF signal boost in both the DL and UL direction such that the resulting Signal to Interference and Noise Ratio (SINR) calculated from the “link budget” provides strong enough signal (at the receiver ends of both the mobile device for DL and the strand small cell for UL) to cover the distance between the strand small cell and the mobile subscriber with a defined minimum “quality of service” in terms of DL + UL throughput and payload capacity for served mobile subscribers that offload to the MSO’s MVNO data offload network.
- **Antenna Pattern / Beamwidth** – Omni antenna arrays should provide consistent gain (low “ripple”) in all directions from the strand (360° for omni antenna arrays) while sector antenna arrays should provide consistent gain over a wide horizontal angle from the strand and have sufficient overlap to support smooth handover (HO) between adjacent sectors (i.e. overlapping 2x180° 3dB beamwidth for 2 sectors, 3 x 120° for 3 sectors, 4x90° for 4 sectors, etc.). Due to the nature of antennas (focusing radiated or received RF power), the wider horizontal beamwidth necessitates a much narrower vertical 3 dB beamwidth (typically +/- 10°) so the resulting focused antenna pattern provides sufficient gain and coverage in all directions of the horizontal plane while also providing enough gain in the vertical/elevation angle to provide DL and UL coverage boost to nearby vertical structures and/or terrain (i.e. hills/dips/buildings, etc.).
- **Ripple** – To be effective, an antenna array pattern should maintain a consistent gain in all desired horizontal directions (typically within 3 dB of the maximum antenna gain). This will facilitate reliable coverage in the desired directions. In the case of an omni configuration, RF planning and strand deployment teams can be assured of meeting the desired coverage, regardless of the small cell orientation. In the case of a desired sector configuration, RF planning and strand deployment teams can be assured of meeting the desired coverage in the targeted directions of each sector.
- **Downtilt** – Wireless antennas can also be mechanically or electrically down-tilted such that the resulting antenna pattern (focusing RF power) is directed vertically downwards by a small amount (typically 5° down for street level coverage). This is done to help contain/control the RF power being radiated horizontally from the antenna to minimize the overlapping interference zones with adjacent/nearby small cells.

The following figure summarizes the key electrical characteristics of an omni antenna array:

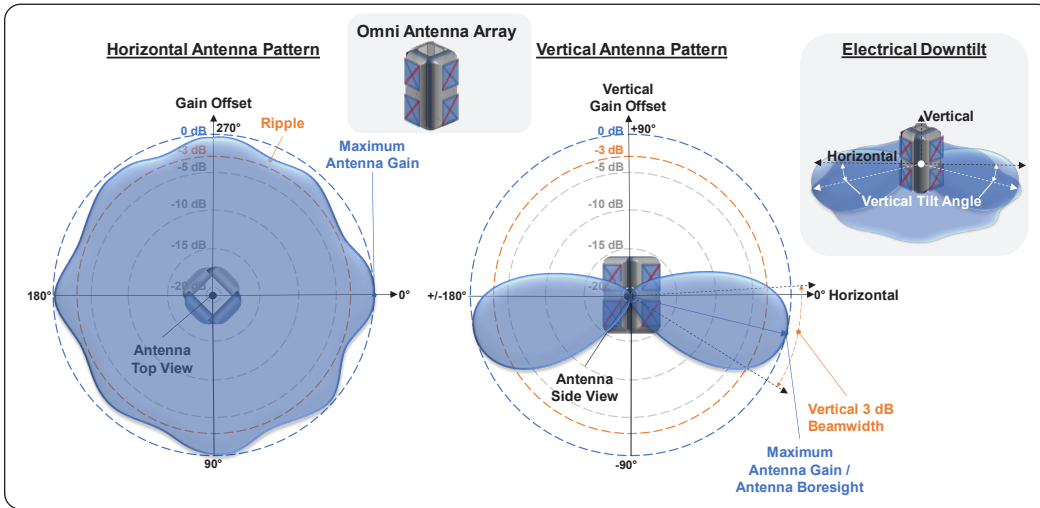

Figure 18 – Electrical Characteristics - Omni Antenna Array

The following figure summarizes the above electrical characteristics of a sector/panel antenna:

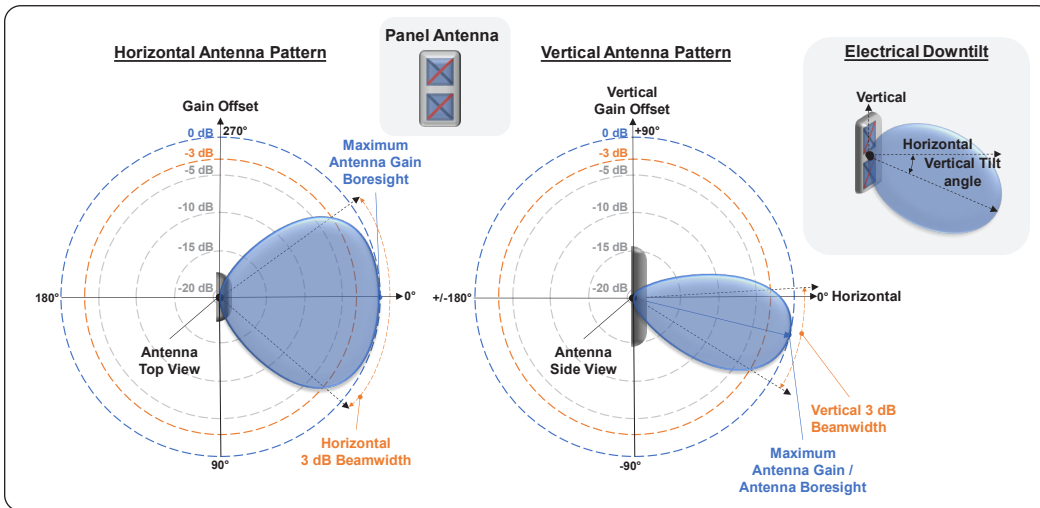

Figure 19 – Electrical Characteristics - Sector / Panel Antenna

Antenna panels may be mounted in the same electrical plane as the small cell chassis to adhere to the physical size and separation requirements of the strand-mounted small cell. In these cases, multiple antenna panels may be mounted around the strand in an “array” such that the resulting antenna pattern is referred to as “pseudo-omni.” The byproduct of the array is the horizontal antenna spacing affects the amount of “ripple” caused by adjacent antenna panels that interfere with each other when they are out of phase.

RF CHAIN (2T2R AND 4T4R)

To improve the reliability and consistency of a wireless RF signal, the antenna array in the strand small cell radio will have at least two RF paths between the mobile device and small cell transmitters and receivers. This provides redundancy of the RF signal since, in a wireless environment, there are many reflections and absorptions of an RF signal that result in a phenomenon called “fading” (the RF signal strength will dip and significantly reduce or drop the connection between the mobile device and small cell radio):

- 2T2R provides this redundancy with significant improvement in compensating for fading effects on one path by a technique called “cross-polarization” (orienting the “antenna elements” in the antenna array such that one path is at $+45^\circ$ rotated from the vertical axis of the small cell radio and the second path is at -45° rotated from the vertical axis of the small cell radio). The cross-polarization technique creates an orthogonal (90°) separation of the collected/radiated antenna array RF signal which results in a significant (typically >30 dB) “discrimination” between both paths such that their RF signal strengths are not correlated, thereby allowing the receiver to choose the stronger signal in case one path between the transmitter and receiver has a degraded/weakened signal due to “fading.” In addition to diversity of the signal, 2T2R provides the possibility of using MIMO techniques to obtain higher throughput in favorable conditions. In reality, there is some variance on practical gains which is dependent on the “fading environment” the strand small cell radio and mobile device are located. For example, in areas of “clutter” (i.e. buildings, vehicles, trees, houses, street furniture, etc.), there will be a higher chance of fading so the 2T2R transmit and receive diversity will be focused on combating fading rather than using MIMO layers for increased data throughput capacity.

- Employing a 4T4R antenna is more complex design than 2T2R, however, it does offer the added benefit of increasing the robustness of 4-way transmit/receive diversity that will further improve fading immunity while also offering increased possibility of higher throughput due to up to 4 layers (unique signals).
- In summary, the tradeoffs between 2T2R and 4T4R are:
 - 2T2R is simpler and therefore, has higher component reliability while 4T4R is more complex,
 - 4T4R requires 2x the antenna elements, hence more physical real estate,
 - 4T4R may have higher power consumption due to the additional components such as RF power amplifiers, and more power hungry processor(s).
 - 4T4R does offer the possibility of higher throughput and more fading immunity in RF environments with high clutter.

The following figure summarizes the key concepts of the RF chain/“plumbing” for a representative xTxR small cell RF chain:

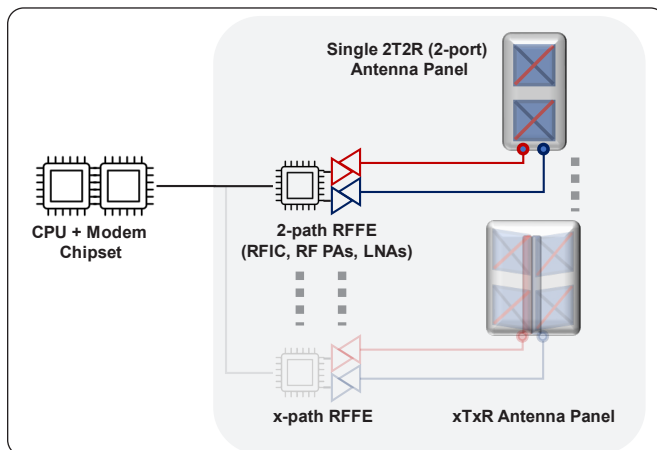

Figure 20 – xTxR Small Cell RF Chain

EFFECTIVE ISOTROPIC RADIATED POWER (EIRP)

Based on the total conducted RF power, RF chain and antenna configuration and gain, the EIRP is the measured “focused” RF power (typically in dBm units) at the maximum gain/“main boresight” of the antenna. It is as if the conducted RF power directed in that particular direction were radiated in all directions. Since antennas essentially focus radiated RF power from a conducted RF power source, the EIRP reflects the effective power measured after antenna gain (in dBi) above a theoretically isotropic/spherical radiated RF source. The following figure summarizes the EIRP concept and calculation:

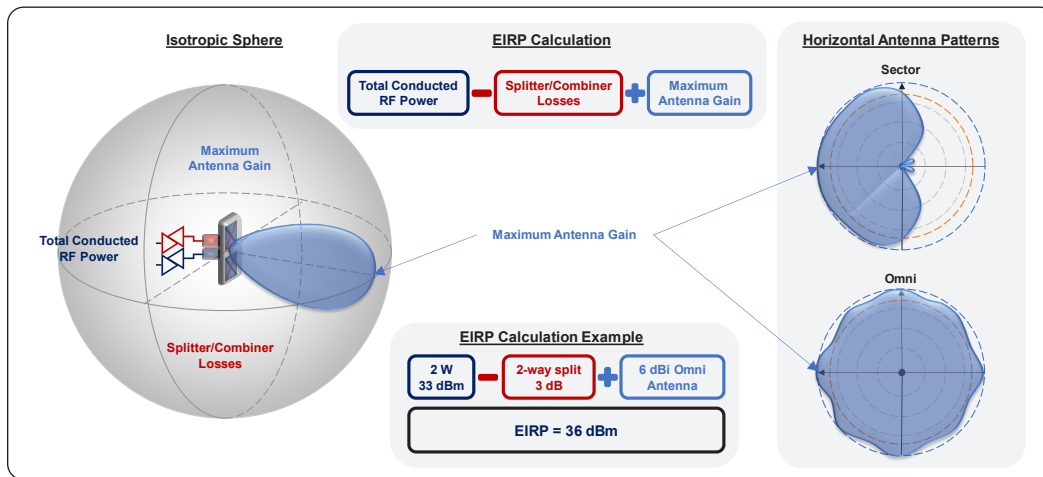

Figure 21 – Effective Isotropic Radiated Power Concept

In the case of CBRS:

- Two different RF power levels/EIRP categories are available as follows:
 - **Category A (indoor CBSDs)** – The maximum EIRP must be no more than 30 dBm/10 MHz
 - **Category B (outdoor CBSDs or CPEs)** – The maximum EIRP must be no more than 47 dBm/10 MHz
- All CBRS transmitters above 6 feet height above average terrain (HAAT), and hence effectively all outdoor strand-mounted small cells, must be Category B certified. However, strand-mounted small cells will typically operate below the maximum allowable EIRP of 47 dBm/10 MHz due to power distribution limitations, as covered in the Sec 4.2.3.

Considering the fundamental EIRP calculation outlined above, the following figure shows the variations on EIRP calculations, depending on the context and how the FCC and CBRS define EIRP and the application of EIRP for use in RF planning through Link Budgets:

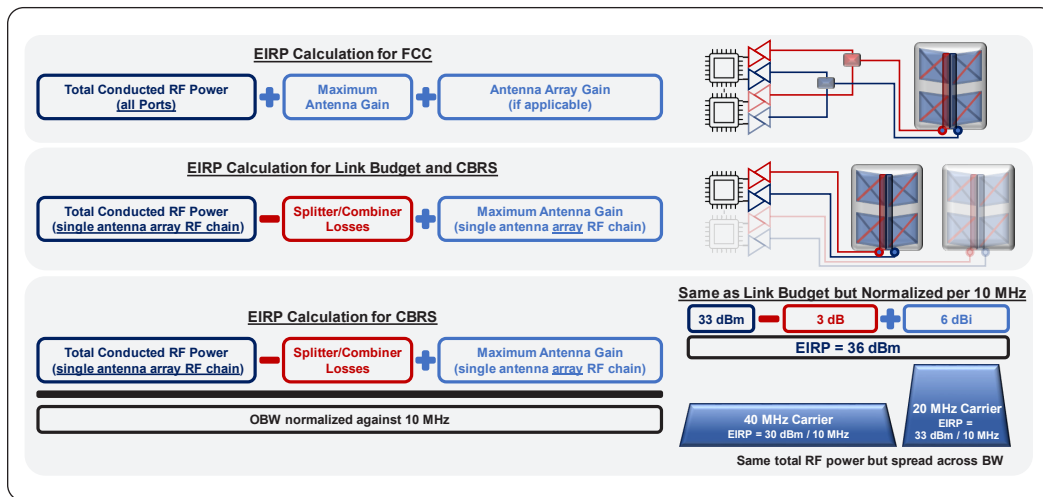

Figure 22 – EIRP Calculation Comparison – FCC, Link Budget, and CBRS

Note the similarities but also the main difference between FCC, Link Budget, and CBRS is how the conducted RF power is distributed in terms of RF chains/splits in antenna arrays and spreading RF power over bandwidth. Essentially, FCC certification means the maximum power spectral density that a CBSD can possibly radiate if all RF power is focused in one direction is within the EIRP limits of the appropriate CBSD Category. The goal of the Link Budget EIRP is to determine the actual coverage based on the RF conducted power focused in a given direction (also used for CBRS SAS planning and channel grants).

NETWORK DESIGN AND OPTIMIZATION

There are several key factors when considering the design, planning, and optimization of wireless coverage and capacity for an MSO MVNO data offload network, including the following:

- **Spectrum** – This provides the foundation for the HMNO network. Depending on the frequency band and available bandwidth, this will determine both the coverage and capacity capabilities of each small cell, aggregated to the HMNO network level for total network coverage and capacity. In addition to targeted CBRS usage areas, the spectrum assets may include other non-CBRS bands for added capacity.
- **AOIs** – A typical strategy for the planning and deployment of strand small cells for the MVNO data offload network is to target locations where current MSO MVNO mobile data users are generating the highest traffic. These are typically around public venues (i.e. corporate campuses, shopping malls, sports complexes, universities, etc.). To maximize the return on investment (ROI) and ensure a healthy business case for total cost of ownership (TCO) of the MVNO data offload network, the strand small cells would be deployed in a targeted way.
- **Wireless network / RAN architecture** – This may consist of a mix of macro, micro, and femto indoor and outdoor radios and Distributed Antenna Systems (DAS) using one or more Radio Access Technologies (RATs). These types of networks are referred to as multi-RAT or Heterogeneous Networks (HetNets) which may include a combination of Wi-Fi and a mix of 3GPP and/or non-3GPP wireless access networks. When correctly designed and optimized, the MSO can leverage the various wireless technology layers and combine them to support robust mobility for their subscribers.
- **Mobility** – While AOIs may be concentrated areas, they may also be high pedestrian or vehicular traffic zones that would require the strand small cells to hand over (HO) to ensure a smooth mobile user experience. This may include leveraging HetNet/multi-RAT HMNO network capabilities to ensure seamless handovers (HOs) between the networks to provide reliable network experience for the end users.

- **Quality of Service (QoS)** – This defines the MSO’s targeted MVNO data offload capacity that will enable the mobile user experience in terms of throughput and latency (both DL and UL). Several factors impact the QoS and resulting cell and network level capacity for the wireless MVNO data offload network: bandwidth, signal strength, and interference. Depending on the DL/UL link budget (small cell specifications, RF environment, etc.), the resulting signal to interference and noise ratio (SINR) will determine which MCS can be used to maximize the throughput over the air interface. Higher SINR results in higher order MCS that provides more information bits and less forward error correction (FEC)/overhead. For example, a 64 Quadrature Amplitude Modulation (QAM) MCS “constellation” will provide lower throughput but higher FEC compared with 256 QAM since 64 QAM has a larger error vector magnitude (EVM) tolerance.
- **DL/UL link budgets** – The downlink and uplink coverage/serving area of the strand small cell is determined by the link budget parameters, including:
 - Wireless transmit/receive specifications of the strand small cell and mobile device, with the following two key strand small cell specifications:
 - EIRP for downlink,
 - Receiver sensitivity for uplink,
 - RF environment (i.e. morphology/clutter),
 - Antenna heights of the strand small cell (typically 20 ft.) and mobile user/user equipment (UE) (typically 3 ft.),
- **Security** – Considering CPEs, other small cells, and other plant equipment are all sharing the same DOCSIS network, IP security (IPsec) tunnels can be established to maintain proper isolation between user and control-plane traffic and virtual private network (VPN) tunnels. Security certificates should be efficiently managed such that the connectivity is reliable.

COVERAGE AND CAPACITY PLANNING

As outlined above, these factors go hand-in-hand in determining the resulting coverage and capacity of the strand small cell network. Depending on the coverage area, QoS, and mobility requirements, the gNB inter-site distance (ISD) can be determined. ISD reflects the average distance between adjacent strand small cells in the MVNO data offload network.

The following figure provides a representative example of how the above-listed factors interact with each other to compare two generic link budgets and resulting coverage/capacity profiles that reflect both uplink limited and downlink limited scenarios:

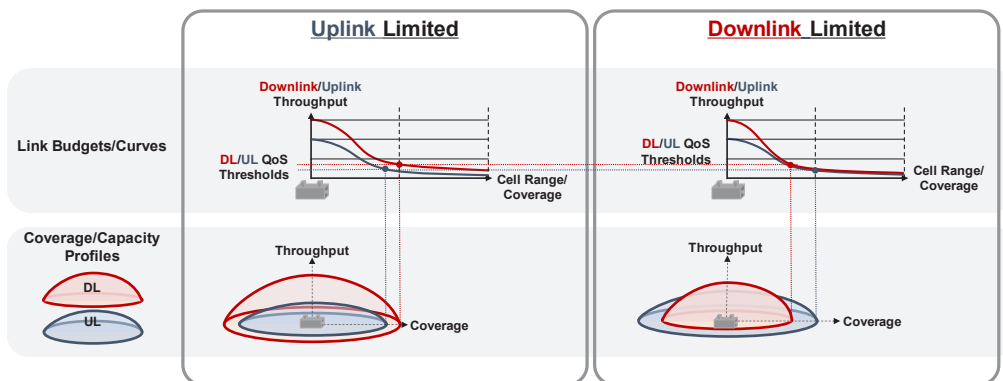

Figure 23 – Wireless Coverage and Capacity

Note that the above coverage exercise is based on the minimum throughput required by a single user at the cell edge. Depending on the combined user traffic demand, the serving area of each small cell may need to be further reduced which would result in increased cell density and smaller ISD.

MOBILITY

In addition to coverage and capacity, a key attribute and planning requirement for the MSO to carefully consider as part of network planning and deployment for effective MVNO data offload in their HMNO network is the mobility/handover locations and frequencies between the MSO's HMNO network and the MNO's network and is supporting the MVNO. The following figure provides a simplified visualization on the mobility of a user travelling in one direction and handing between the MSO's HMNO and MNO's network:

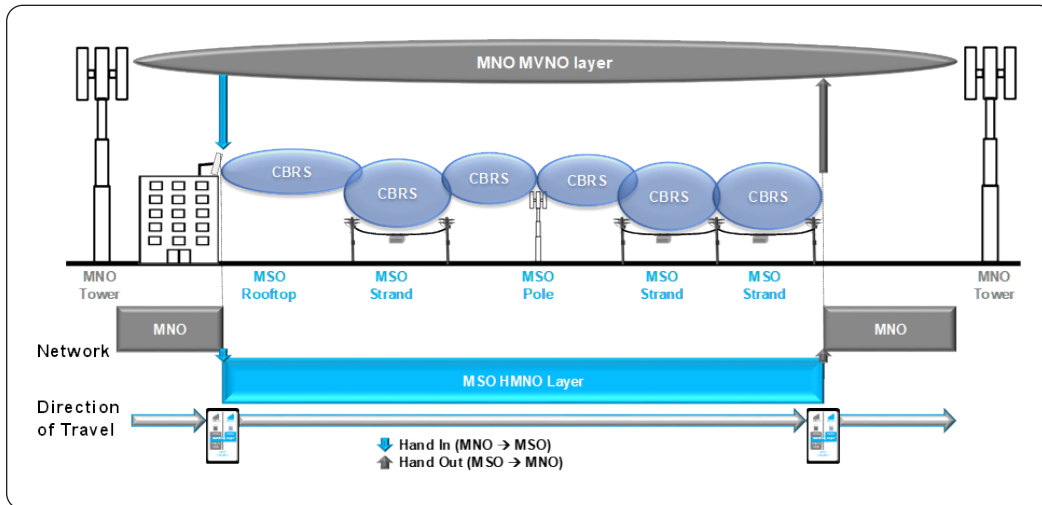

Figure 24 – MNO to MSO MVNO Data Offload – Mobility

The concepts referenced earlier in section 5 (i.e. Spectrum, Network architecture, QoS, ISD, etc.) should be considered as part of Mobility. In addition, the following should also be considered to ensure optimum mobility performance of the HMNO network:

- **Neighbors/Adjacent cells/HO Parameters** – These should be correctly defined to ensure correct HO and mobility between the different cells.
- **Traffic prioritization** – Since small cell and broadband traffic will both be sharing the same DOCSIS downstream and upstream resources and also Operations and Maintenance (O&M) control traffic will be sharing the same medium (DOCSIS and wireless), it is important to be able to prioritize traffic layers to ensure reliable network performance for the end user experience.

DEPLOYMENT AND OPERATIONS

As outlined previously, the MSO should consider many factors when choosing where to deploy small cells (i.e. user density, power budget, RF engineering, coverage area, etc.). Additionally, operators face the following deployment challenges when deploying small cells:

- The small cell's location will not always coincide with the availability of utility power or fiber for backhaul.
- Zoning, site acquisition, permitting and regulations can delay installations by months.
- Project schedules can be significantly delayed due to delays getting meters installed by the local utility.
- Utility power is prone to outages and disturbances.
- High-speed, low-latency backhaul may be cost-prohibitive to deliver if construction is required.

The major deployment challenges listed above are overcome when the MSOs utilize their existing HFC infrastructure to deploy strand-mount small cells. An important feature that ensures smooth deployment and operations of the MSO's strand small cell network is plug and play (PnP) functionality. As the name implies, both DOCSIS and small cell parameters and features are pre-configured to make the field deployment and operations and maintenance of the strand small cell network more efficient.

THE MAJOR DEPLOYMENT CHALLENGES LISTED ABOVE ARE OVERCOME WHEN THE MSOS UTILIZE THEIR EXISTING HFC INFRASTRUCTURE TO DEPLOY STRAND-MOUNT SMALL CELLS.

Once the strand small cell sites are chosen, the MSO can deploy their Outside Plant (OSP) technicians to install the small cell. The OSP technicians must also be Certified Professional Installer (CPI) certified based on WInnForum accreditation, in order to meet FCC Part 96 rules for Category B CBSD deployment. The CPI certification ensures that the key CBSD installation and configuration parameters (i.e. small cell location, antenna height, EIRP, antenna type (omni/sector), azimuth, etc.) are verified and loaded into the strand small cell and SAS in order to ensure the SAS database accurately reflects the deployed field installation of the strand small cell. This is critically important since the SAS must accurately manage the channel and frequency coordination

of channel grants and releases to minimize interference between the MSO's strand small cell CBSDs and other operator's neighboring CBSDs.

Besides CPI certification and additional power and backhaul planning considerations, the MSO OSP teams have the advantage to operate and deploy their new strand small cell network freely, following similar operating procedures as per their mainstream broadband strand mounted HFC network. In particular, the OSP team can efficiently coordinate deployment and operations of both their broadband HFC network and overlaid HMNO network since they do not need additional permissions, permits, leasing, zoning or worry about pole attachments. Once the strand small cells are installed, powered up, and commissioned, they are ready to integrate into the HMNO network to support the MVNO data offload in the AOIs they are deployed.

As commercial MVNO data offload traffic starts to take off in the MSO's new HMNO network, the MSO should also consider the ongoing capacity planning to account for increasing traffic growth on both the DOCSIS and HMNO network and maximize the data offload performance. For the radio access network, this will involve optimizing the channel bandwidth, frequencies, power levels, and handover parameters. For the DOCSIS network, this will involve optimizing plant power and HFC parameters and network architecture that influence downstream/upstream channel capacity. In both cases, the wireless and broadband network architecture evolution and supporting equipment roadmaps will be considered to achieve optimum performance to meet subscriber needs and the MSO business case.

CONCLUSION

This paper is an effort to provide a comprehensive, yet efficient, compilation of the various concepts that the MSO community should consider as part of adding an HMNO network. This paper addresses both Cable and Wireless network engineering considerations including:

- Optimizing power consumption for maximum performance
- Supporting flexible cable modem frequency splits across different MSOs
- Preventing ingress/egress/spurious noise to isolate DOCSIS coax RF from wireless RF
- Antenna design, form-factor, and gain
- Wireless coverage and capacity planning
- Utilizing optimum radio network components to maximize data offload performance

It is hoped that this paper has achieved the goal; to provide a comprehensive guide for the MSOs to refer to as they move forward into expanding their respective convergence portfolios to include MNVO data offload. Through leveraging the MSO's HFC network (including right-of-way, power, and backhaul), the MSO now has new 5G strand small cell technology available to them as an enabler to further expand their wireless HMNO network portfolio to maximize their MNVO data offload capabilities.

ABBREVIATIONS

2T2R	2 transmit 2 receive [2 RF paths for [small cell] radio DL+UL]
3GPP	3rd Generation Partnership Project [standards organization]
4T4R	4 transmit 4 receive [4 RF paths for [small cell] radio DL+UL]
4G	4th Generation 3GPP standard [encompasses RAN and core]
5G	5th Generation 3GPP standard [encompasses RAN and core]
AAC	Amps Alternating Current
AF	Application Function
AMF	Access & Mobility Management Function [3GPP nomenclature for 5G core network element managing control-plane functionality]
ANSI	American National Standards Institute
AOI	area of interest
AUSF	Authentication Server Function
B48	4G-LTE frequency band for CBRS (3550-3700 MHz)
BH	busy hour
bps	bits per second
CA	Carrier Aggregation
CC	Component Carriers
CBRS	Citizens Broadband Radio Service allocated to 3550-3700 MHz band
CBSD	Citizens Broadband Radio Service Device
CCAP	Converged Cable Access Platform
CM	cable modem
CMTS	cable modem termination system
CPE	customer premises equipment
DAS	Distributed Antenna System
dB	decibel [used for relative comparison of RF units on logarithmic scale = $10 * \log$ (ratio of RF unit)]
dBi	dB isotropic [logarithmic unit to define the relative gain of an antenna]
dBm	dB milliwatts [logarithmic unit for RF conducted or radiated power = $10 * \log$ (RF power level in milliwatts)]
dBmV	dB millivolts [logarithmic unit for millivolts]
DC	directional coupler [depending on context]
DC	data center [depending on context]
DL	downlink
DN	Data Network [operator services, internet access, other services]
DOCSIS	Data Over Cable Service Interface Specification
DSDS	dual-SIM dual-standby
EIRP	Effective Isotropic Radiated Power
EMS	element management system

ESD	extended spectrum DOCSIS
EVM	Error Vector Magnitude
FCC	Federal Communications Commission
FDD	Frequency Division Duplex
FDMA	Frequency Division Multiple Access
FDX	Full Duplex DOCSIS
FEC	forward error correction
FR1	Frequency Range 1 [3GPP standard nomenclature for sub-6 GHz]
FR2	Frequency Range 2 [3GPP standard nomenclature for above-6 GHz]
GAA	General Authorized Access
Gb	Gigabit
Gbps	gigabits per second
GB	Gigabyte
gNB	5G Node B [3GPP standards radio]
GTEM	Giga Transverse ElectroMagnetic
HAAT	height above average terrain
HetNet	Heterogeneous Network
HFC	Hybrid Fiber Coaxial
HMNO	Hybrid Mobile Network Operator
HO	Handover
I2C	Inter Integrated Controller
IBW	instantaneous bandwidth
IoT	Internet of Things
IOT	inter-operability testing
IP67	Ingress Protection 6 (dust) 7 (liquids)
IPsec	Internet Protocol Security
ISD	inter-site distance
LTE	Long Term Evolution [4th generation 3GPP air interface standard]
MAPL	Maximum Allowable Path Loss
Mb	megabit
Mbps	megabits per second
MB	megabyte
MCS	Modulation and Coding Scheme
MDD	MAC Domain Descriptor
MHz	megahertz
mmWave	millimeter wave spectrum [3GPP refers to as FR2 - above 6 GHz]
MNO	Mobile Network Operator

MSO	Multiple System Operator
MVNO	Mobile Virtual Network Operator
n48	5G-NR frequency band for CBRS (3550-3700 MHz)
NEF	Network Exposure Function
NGC	Next Generation Core [5th generation 3GPP core]
NOC	Network Operation Center
NR	New Radio [5th generation 3GPP air interface standard]
NRF	NF Repository Function
NSSF	Network Slice Selection Function
O&M	Operations and Maintenance
OBW	occupied bandwidth
OFDM	Orthogonal Frequency Division Multiplexing
OFDMA	Orthogonal Frequency Division Multiple Access
OFR	operating frequency range
OSI	Open Systems Interconnection
OSP	outside plant
PAL	Priority Access License
PCF	Policy Control Function
PHY	physical layer
PnP	plug and play
PPT	power passing tap
PSD	power spectral density
QAM	Quadrature Amplitude Modulation
QPSK	Quadrature Phase Shift Keying
RAN	Radio Access Network [3GPP terminology for wireless network architecture]
RAT	Radio Access Technology
RF	radio frequency [depending on context, may refer to wireless or cable]

RFFE	RF front end [the transmitter/receiver block of a [small cell] radio]
ROI	return on investment
SAS	Spectrum Access System
SCA	Software Communications Architecture
SC-QAM	Single-Carrier Quadrature Amplitude Modulation
SCTE	Society of Cable Telecommunications Engineers
SDR	Software Defined Radio
SDS	Software Defined Systems
SIM	Subscriber Identity Module [3GPP standard nomenclature]
SINR	Signal to Interference and Noise Ratio
SMF	Session Management Function
SRA	Software Radio Architecture
TCO	total cost of ownership
TDD	Time Division Duplexing [shared DL + UL using single frequency]
TLV 84	type, length, value 84 [configuration state of the RF plant]
UDM	Unified Data Management
UE	User Equipment [3GPP terminology for mobile device]
UL	uplink [depending on context]
UL	Underwriter Laboratories [depending on context]
UPF	User Plane Function [3GPP nomenclature for 5G core network element managing user-plane functionality]
µW	microwatts
VAC	Volts Alternating Current
VPN	Virtual Private Network
WInnForum	Wireless Innovation Forum [non-profit wireless standards organization]
WISP	Wireless Internet Service Provider

ENDNOTES

- 1 Reference: <https://www.fcc.gov/auction/105>
- 2 Cable providers using existing network to build wireless cheaper, say panelists; Fogarty; S&P Global; 10/15/2020; <<https://www.spglobal.com/marketintelligence/en/news-insights/latest-news-headlines/cable-providers-using-existing-network-to-build-wireless-cheaper-say-panelists-60753719>>
- 3 Source: <https://www.ncta.com/broadband-facts>
- 4 Source: <https://www.3gpp.org/technologies/5g-system-overview>
- 5 Reference: <https://ongoalliance.org/>
- 6 Reference: <https://www.wirelessinnovation.org/>
- 7 Reference: <https://www.3gpp.org/>
- 8 Reference: <https://www.cablelabs.com/>
- 9 Reference: <https://www.fcc.gov/>
- 10 Reference: <https://www.ul.com/>
- 11 References: <http://www.ojua.org/wp-content/uploads/2009/03/rule-235h-history.pdf> and <https://standards.ieee.org/wp-content/uploads/import/documents/interpretations/ir523.pdf>
- 12 Reference: <https://www.scte.org/standards/library/catalog/scte-40-digital-cable-network-interface-standard/>
- 13 Reference: <https://www.scte.org/standards/library/catalog/scte-48-1-test-method-for-measuring-shielding-effectiveness-of-passive-and-active-devices-using-a-gtem-cell/>
- 14 Definition: BAFF = Industry standard term for hardline to F, female connector



World Headquarters
2366 Bernville Road
Reading, PA 19605 USA
+1 610-208-1991 / +1 800-538-3627

EnerSys EMEA
EH Europe GmbH
Baarerstrasse 18
6300 Zug Switzerland

EnerSys Asia
152 Beach Road
Gateway East Building #11-08
Singapore 189721 / +65 6416 4800