

**cordex** HP  
HIGH PERFORMANCE

# Cordex<sup>®</sup> HP eLimiter+ 100VA Class 2 Distribution System

User Guide ID: 0120028-J0

Effective: 05/2022



**Read this document carefully.**

Learn how to protect your equipment from damage and fully understand its functions.



# Cordex<sup>®</sup> HP eLimiter+ 100 VA Class 2 Distribution System



## NOTICE

For the latest version of software, firmware, and product documentation, visit the Alpha<sup>®</sup> website, [www.alpha.com](http://www.alpha.com) or [www.alpha.ca](http://www.alpha.ca).



## NOTICE

Photographs contained in this document are for illustrative purposes only. These photographs may not match your installation.



## NOTICE

Operator is cautioned to review the drawings and illustrations contained in this document before proceeding. If there are questions regarding the safe operation of this powering system, contact Alpha Technologies Ltd. or your nearest Alpha<sup>®</sup> representative.



## NOTICE

EnerSys shall not be held liable for any damage or injury involving its enclosures, power supplies, generators, batteries, or other hardware if used or operated in any manner or subject to any condition inconsistent with its intended purpose, or if installed or operated in an unapproved manner, or improperly maintained.

## Copyright notice

© 2022 EnerSys. All rights reserved. Trademarks and logos are the property of EnerSys and its affiliates unless otherwise noted. Subject to revisions without prior notice. E. & O.E.

No part of this documentation shall be reproduced, stored in a retrieval system, translated, transcribed, or transmitted in any form or by any means manual, electric, electronic, electromechanical, chemical, optical, or otherwise without prior explicit written permission from EnerSys.

This document, the software it describes, and the information and know-how they contain constitute the proprietary, confidential and valuable trade secret information of EnerSys, and may not be used for any unauthorized purpose, or disclosed to others without the prior written permission of EnerSys.

The material contained in this document is for information only and is subject to change without notice. While reasonable efforts have been made in the preparation of this document to assure its accuracy, EnerSys assumes no liability resulting from errors or omissions in this document, or from the use of the information contained herein. EnerSys reserves the right to make changes in the product design without reservation and without notification to its users.

# Contents

1. Safety.....	7
1.1 Safety symbols.....	7
1.2 General warning and cautions.....	7
1.3 Mechanical safety.....	8
1.4 Electrical safety.....	8
2. Product overview.....	9
2.1 Introduction.....	9
2.2 Features and benefits.....	9
2.3 Product part numbers.....	10
3. Specifications.....	11
4. Features.....	13
4.1 Converter modules.....	13
4.2 Cordex® CXCi HP controller.....	14
4.3 Shelf connections and indicators.....	17
4.4 Shelf accessories.....	18
5. Inspection.....	19
5.1 Packing materials.....	19
5.2 Returns for service.....	19
5.3 Check for damage.....	19
5.4 General receipt of shipment.....	19
5.5 Miscellaneous small parts.....	19
6. System installation.....	20
6.1 Installation location.....	20
6.2 Pre-installation requirements.....	20
6.3 General instructions.....	20
6.4 Safety precautions.....	20
6.5 Tools required.....	20
6.6 Setting the shelf ID.....	21
6.7 Rack mounting.....	21



6.8	I/O wiring .....	24
6.9	Wiring the alarm relays .....	31
6.10	Installing the controller and converters .....	33
6.11	System startup .....	36
6.12	Summary of controller software .....	37
6.13	Cordex® HP eLimiter+ channel grouping .....	38
6.14	Cordex® HP eLimiter+ channel custom text .....	38
6.15	Cordex® HP eLimiter+ alarms .....	39
7.	Maintenance and troubleshooting .....	40
7.1	Fan tray replacement .....	40
7.2	Troubleshooting Cordex® HP eLimiter+ status LEDs .....	41
7.3	Troubleshooting the fan tray status LED .....	42
7.4	Service kits .....	42
7.5	Replacing the controller .....	43
7.6	Replacing the Cordex® HP eLimiter+ modules .....	43
7.7	Replacing an alarm relay .....	44
8.	Acronyms and definitions .....	46

# Figures

Figure 1: Cordex® HP eLimiter+ shelf .....	9
Figure 2: Converter status LEDs .....	13
Figure 3: Cordex® CXCi HP controller front panel .....	14
Figure 4: Cordex® CXCi HP controller menu .....	15
Figure 5: In-shelf controller buttons .....	16
Figure 6: Shelf connections .....	17
Figure 7: Shelf alarm LEDs .....	17
Figure 8: Fan and baffle tray rack mounted .....	18
Figure 9: Setting the shelf ID .....	21
Figure 10: Multi-shelf system mounting .....	21
Figure 11: Thermal management without a fan tray .....	23
Figure 12: Locations for protective earthing terminals for chassis ground (side view).....	24
Figure 13: DC input connections .....	25
Figure 14: DC input wiring connections .....	25
Figure 15: Remove the center screw.....	26
Figure 16: Formex separators between the inputs .....	26
Figure 17: Cut lines for cable input .....	27
Figure 18: Cover cut complete.....	27
Figure 19: CAN connections on the shelf interface panel .....	28
Figure 20: CAN bus cabling.....	28
Figure 21: Fan tray connections .....	29
Figure 22: Terminal block and connector pinouts .....	29
Figure 23: Recommended load wiring connections .....	29
Figure 24: Channel designation card.....	30
Figure 25: Inserting the channel designation card.....	30
Figure 26: Converter shelf alarm relays .....	31
Figure 27: Fan tray alarm relay.....	31
Figure 28: Group reset switches .....	32
Figure 29: Default setting, independent outputs .....	32
Figure 30: Group reset enabled .....	32

Figure 31: Installing converters ..... 34

Figure 32: Securing the wires ..... 35

Figure 33: Installing the back cover ..... 35

# 1. Safety

## Save these instructions

This document contains important safety instructions that must be followed during the installation, servicing, and maintenance of the product. Keep it in a safe place. Review the drawings and illustrations contained in this document before proceeding. If there are any questions regarding the safe installation or operation of this product, contact Alpha Technologies Ltd. or the nearest Alpha® representative.

### 1.1 Safety symbols

To reduce the risk of injury or death, and to ensure the continued safe operation of this product, the following symbols have been placed throughout this document. Where these symbols appear, use extra care and attention.



#### WARNING

##### Risk of serious injury or death

Equipment in operation poses a potential electrical hazard which could result in serious injury or death to personnel. This hazard may continue even when power is disconnected.



#### CAUTION

Cautions indicate the potential for injury to personnel.



#### CAUTION

##### Risk of burns

A device in operation can reach temperature levels which could cause burns.



#### ATTENTION

The use of attention indicates specific regulatory or code requirements that may affect the placement of equipment or installation procedures. Follow the prescribed procedures to avoid equipment damage or service interruption.



#### GROUNDING

This symbol indicates the location or terminal intended for the connection to protective earth. An enclosure that is not properly connected to protective earth presents an electrical hazard. Only a licensed electrician can connect AC power and protective earth to the enclosure.



#### NOTICE

A notice provides additional information to help complete a specific task or procedure or general information about the product.

### 1.2 General warning and cautions



#### WARNING

This system is designed to be installed in a restricted access location that is inaccessible to the general public.

- Read and follow all instructions included in this document.
- Only trained personnel are qualified to install or replace this equipment and its components.
- Use proper lifting techniques whenever handling equipment, parts, or batteries.

## 1.3 Mechanical safety

- Keep hands and tools clear of fans. Fans are thermostatically controlled and switch on automatically.
- Power supplies can reach extreme temperatures under load.
- Use caution around sheet metal components and sharp edges.

## 1.4 Electrical safety



### WARNING

Hazardous voltages are present at the input of power systems. The DC output from rectifiers, though not dangerous in voltage, has a high short-circuit current capacity that can cause severe burns and electrical arcing.

The DC output from converters is a potentially hazardous voltage. Do not touch the output connections when under power. Ensure that power has been removed from the outputs before working on them.

Before working with any live battery or power system, follow these precautions:

- Remove all metallic jewelry, such as watches, rings, metal rimmed glasses, or necklaces.
- Wear safety glasses with side shields at all times during the installation.
- Use OSHA approved insulated hand tools. Do not rest tools on top of batteries.



### WARNING

Lethal voltages are present within the power system. Always assume that an electrical connection or conductor is energized. Check the circuit with a voltmeter with respect to the grounded portion of the enclosure (both AC and DC) before performing any installation or removal procedure.

- Do not work alone under hazardous conditions.
- A licensed electrician is required to install permanently wired equipment. Hazardous voltages are present at the input of power systems. Ensure that the utility power is disconnected and locked out before performing any installation or removal procedure.
- Ensure that no liquids or wet clothes come into contact with internal components.
- Hazardous electrically live parts inside this unit are energized from the batteries even when the AC input power is disconnected.
- Always assume electrical connections or conductors are live. Turn off all circuit breakers and double-check with a voltmeter before performing installation or maintenance.
- Place a warning label on the utility panel to warn emergency personnel that a reserve battery source is present which will power the loads in a power outage condition or if the AC disconnect breaker is turned off.
- At high ambient temperature conditions, the internal temperature can be hot so use caution when touching the equipment.



### WARNING

#### High leak current

Earth connection is essential before connecting the supply.



### CAUTION

Internal DC breakers can be hot surfaces. Use a bullet socket removal tool for removal of circuit breakers.

## 2. Product overview

### 2.1 Introduction

The Cordex® HP eLimiter+ is a unique remote powering solution that meets the NEC requirements for remote powering of electrical devices such as iDAS (indoor distributed antenna systems), remote radios, security cameras, various sensors, access controllers, and alarms. The device can be used to distribute –48 Vdc to remote equipment without the use of conduits and complies with the NEC requirement for Class 2 power limited circuits. Power circuits can be combined with fiber optic cables in cost effective easy-to-install composite cables.

The Cordex® HP eLimiter+ reduces capital expenditure costs for deployment and simplifies installation of equipment that requires remote powering such as distributed antenna system equipment.

### 2.2 Features and benefits

- High efficiency >92 percent for increased operating expenses savings and reduced carbon footprint.
- High temperature tolerance for installation in central office or harsh outside plant cabinet environment.
- Industry leading power density enabling up to 36 channels in a compact 2RU form factor.
- High reliability convection-cooled design with optional fan tray.
- Cordex® CXCi HP system controller provides advanced remote web based monitoring and control features. For more information, refer to the [Cordex® CXC HP controller documentation](#).



- 1 Mid-mount brackets
- 2 Shelf interface panel
- 3 Cordex® CXCi HP controller

- 4 Cordex® HP eLimiter+ (slots 1 to 9)
- 5 Front input terminals

Rear input connections (not shown)

Figure 1: Cordex® HP eLimiter+ shelf

The Cordex® HP eLimiter+ system consists of one or more converter modules and a controller installed in a common shelf.

The 19-inch shelf can have up to nine modules. Each converter module contains four isolated DC-DC converters, up to 100 watt maximum. Input connections can be made at the side-rear of the unit as well as the side-front. Additional connections are available at the shelf interface panel for alarm interfaces. Output connections are made at the back of the shelf.

Controller and converter modules are purchased separately at the time of ordering or later once the converter system has been installed. Blanks can be ordered separately for empty slots.

## 2.3 Product part numbers

<b>Product</b>	<b>Part number</b>
Cordex® HP eLimiter+ shelf	0300156-001
Cordex® HP eLimiter+ modules	0120028-001
Cordex® CXCi HP controller	0180053-001
Fan tray	0300055-002
Air baffle	0300055-003
Blanks (two blank modules per package)	0380070-001

### 3. Specifications

<b>Electrical</b>	
<b>Input voltage</b>	–40 to –60 Vdc
<b>Recommended breaker size</b>	70 A per feed
<b>Recommended cable size</b>	Minimum 16 mm <sup>2</sup> (6 AWG) copper rated for 110°C (230°F)
<b>Output voltage</b>	–57 Vdc
<b>Power</b>	98W nominal per output, ± 2W tolerance (four outputs per module)
<b>Efficiency</b>	>92%
<b>Regulation</b>	<ul style="list-style-type: none"> <li>• &lt;2% no load to full load</li> <li>• &lt;1% line</li> </ul>
<b>Noise</b>	
<b>Wide band</b>	<ul style="list-style-type: none"> <li>• &lt;50 mVRMS (10 kHz to 10 MHz)</li> <li>• &lt;100 mV pk-pk (10 kHz to 100 MHz)</li> </ul>
<b>Acoustic</b>	<60 dBA at 1 m (3 ft), 55°C (131°F)
<b>Connections</b>	
<b>Input</b>	<ul style="list-style-type: none"> <li>• <b>HOT:</b> 2 × sets, 1/4 inch studs on 5/8 inch centers</li> <li>• <b>RTN:</b> 2 × sets, 1/4 inch studs on 5/8 inch centers</li> </ul>
<b>Output</b>	9 × 8 position screw door TB (0.14 to 4 mm <sup>2</sup> ; 26 to 12 AWG)
<b>Mechanical</b>	
<b>Quad output power module</b>	
<b>Dimensions (H × W × D)</b>	86 × 35 × 283 mm (3.4 × 1.4 × 11.1 in.)
<b>Weight</b>	0.61 kg (1.4 lb)
<b>Shelf</b>	
<b>Dimensions (H × W × D)</b>	<ul style="list-style-type: none"> <li>• 89 × 435 × 432 mm (3.5 × 17.1 × 17 in.) with cover</li> <li>• 89 × 435 × 329 mm (3.5 × 17.1 × 12.95 in.) without cover and customer connections</li> </ul>
<b>Weight</b>	5.45 kg (12 lb)
<b>Environmental</b>	
<b>Operating temperature</b>	
<b>Forced air cooling</b>	–40 to 65°C (–40 to 149°F) with minimum cabinet air flow at 94.4 L/s (200 CFM)
<b>Convection cooling</b>	–40 to 45°C (–40 to 122°F) single shelf operation only or separated by 3RU includes air baffle
<b>Temperature storage</b>	–40 to 85°C (–40 to 185°F)
<b>Relative humidity</b>	0 to 95% non-condensing
<b>Elevation</b>	–500 to 2800 m (–1640 to 9186 ft)
<b>Heat dissipation</b>	<34.58 watts (<118 BTU/hr) per module
<b>NEBS/Telcordia</b>	Class 3- Protected Equipment in Severe Outside Environment



Performance/features	
<b>Communication ports</b>	
<b>CAN</b>	Smart peripherals
<b>Ethernet</b>	10/100 BASE-T for TCIP/SNMP features
<b>Alarm relays</b>	<ul style="list-style-type: none"> <li>• 1 × Form C major</li> <li>• 1 × Form C minor</li> <li>• 1 × Form C fan tray alarm</li> </ul>
<b>LEDs</b>	
<b>Module</b>	One tri-color LED per converter (see <a href="#">Table A</a> ).
<b>Shelf</b>	<ul style="list-style-type: none"> <li>• <b>Green:</b> System OK</li> <li>• <b>Yellow:</b> Minor alarm</li> <li>• <b>Red:</b> Major alarm</li> </ul>
<b>Fan tray</b>	<ul style="list-style-type: none"> <li>• <b>Off:</b> System OK</li> <li>• <b>Red:</b> Major alarm</li> </ul>
Reliability	
<b>MTBF</b>	> 400,000 hours at 30°C (86°F) ambient; test model Telcordia SR-332, Issue 2 (2006)
Agency compliance	
<b>Safety</b>	CSA/UL No 60950-1
<b>EMC</b>	<ul style="list-style-type: none"> <li>• FCC CFR 47 PART 15/B – Class A</li> <li>• CAN ICES-003(A) / NMB-003(A)</li> <li>• ETSI 300 386</li> <li>• EN 61000-4-2</li> <li>• EN 61000-4-3</li> <li>• EN 61000-4-4</li> <li>• EN 61000-4-5</li> <li>• EN 61000-4-6</li> <li>• EN 61000-4-8</li> </ul>
<b>NEBS/Telcordia</b>	<ul style="list-style-type: none"> <li>• GR-1089-CORE</li> <li>• GR-63-CORE</li> </ul>
<b>NEC</b>	<ul style="list-style-type: none"> <li>• Output circuits compliant to NEC article 725 (CEC article 16-200) requirements for Class 2 power limited circuits</li> <li>• Output circuits compliant to the NEC Article 830.15 Power Limitation requirements for Network Powered Broadband communications systems Class 2 output</li> </ul>
<b>Isolation</b>	2250 Vdc electrical isolation between output and earth or chassis (compliant with IEEE 802.3 at standard to meet PoE+ isolation requirement)
<p><b>Note:</b> This equipment has been tested and found to comply with the limits for a Class A digital device, pursuant to part 15 of the FCC Rules. These limits are designed to provide reasonable protection against harmful interference when the equipment is operated in a commercial environment. This equipment generates, uses, and can radiate radio frequency energy and, if not installed and used in accordance with the instruction manual, may cause harmful interference to radio communications. Operation of this equipment in a residential area is likely to cause harmful interference in which case the user will be required to correct the interference at his own expense.</p>	

# 4. Features

## 4.1 Converter modules

Each module contains four isolated DC to DC converters with a common control and supervisory circuit. An internal microcontroller monitors both the inputs and outputs of the converters, turns the converters on and off, and generates a converter fail alarm if required. Each module output operates independently.

### 4.1.1 Status LEDs

The converter module has four LEDs. Refer to [section 7.2](#) for more details. The LEDs are color-coded to indicate converter status as follows:

LED state	Converter status
<b>Green</b>	Normal
<b>Blinking green</b>	Remote shutdown enabled on individual channel or converter
<b>Blinking green (all four LEDs)</b>	Remote shutdown enabled on whole module
	Shelf is not compatible with the module
	Module not seated properly
<b>Yellow (all four LEDs)</b>	<b>Recoverable:</b> Ambient temperature high
<b>Blinking yellow (all four LEDs)</b>	Input qualify not OK
<b>Blinking yellow</b>	<b>Recoverable:</b> OCP/Overload
	<b>Non-recoverable:</b> Converter input fuse fail
<b>Red</b>	<b>Locked-State:</b> OVP
	<b>Non-recoverable:</b> Converter output fuse fail
<b>Blinking red</b>	<b>Non-recoverable:</b> Secondary sensory fail
<b>OFF (all four LEDs)</b>	<b>Recoverable:</b> No power
	<b>Non-recoverable:</b> Main input fuse cut-off
<b>Chasing green pattern (all four LEDs)</b>	<b>Non-recoverable:</b> Group reset function not working
<b>Chasing red and green pattern (all four LEDs)</b>	Locate feature enabled



Figure 2: Converter status LEDs

## 4.2.2 Converter alarms

Two (converter fail) outputs are present at the card edge connector. Alarms are activated after a one second delay for the following conditions:

- Internal regulation fails
- Output voltage <45 V
- Over voltage protection (OVP) operation
- Secondary current sensor fail
- Input fuse or output fuse fail
- Output short circuit  $\leq 1$  V
- Input voltage out of range
- Heatsink or ambient temperature out of range (over temperature protection).

## 4.2 Cordex® CXCI HP controller

The Cordex® CXCI HP controller is mounted in the converter system shelf and brings advanced monitoring technology to the Cordex® HP series of converters. This compact system controller is equipped with the complete range of software features, including the following:

- Ethernet port for local and remote communications
- User definable alarms
- Daily logging of power system events and system statistics.

Cordex® CXCI HP in-shelf controllers have an OLED display. This display shows 30 characters total (five lines high, six characters wide) and the controller has three navigation buttons and one reset button.

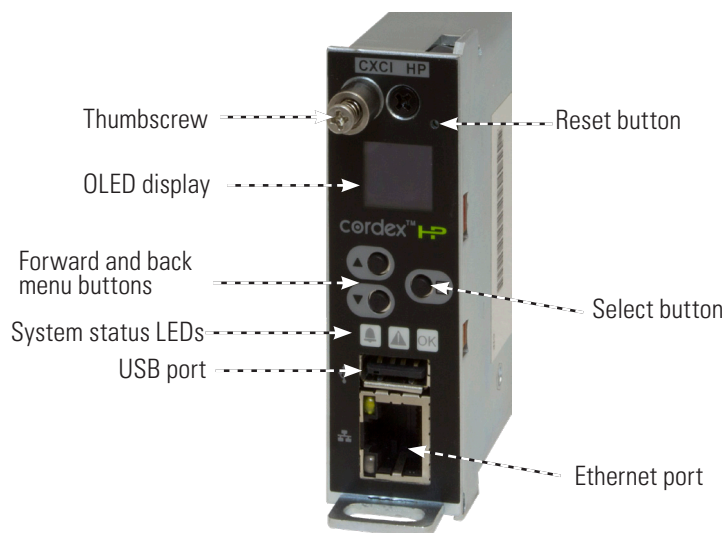

Figure 3: Cordex® CXCI HP controller front panel

The in-shelf display has three main operating modes: dashboard, menu, and screen saver. After 20 minutes with no activity, the in-shelf controller goes into screen saver mode and the display shuts off. From screen saver mode, select any of the three navigation buttons to re-activate the screen and enter dashboard mode.

### 4.2.1 Display

In dashboard mode, the in-shelf display shows the key operating parameters of a system. For example, output voltage and load current. If more than one system is defined, you can cycle between systems using the **Forward** and **Back** buttons. With multiple systems, you can specify a default system, which is then displayed first.

Refer to the **Cordex® CXC HP Controller Software Manual (User Guide ID: 0350058-J0)** for set up information. The following figure shows screen examples.

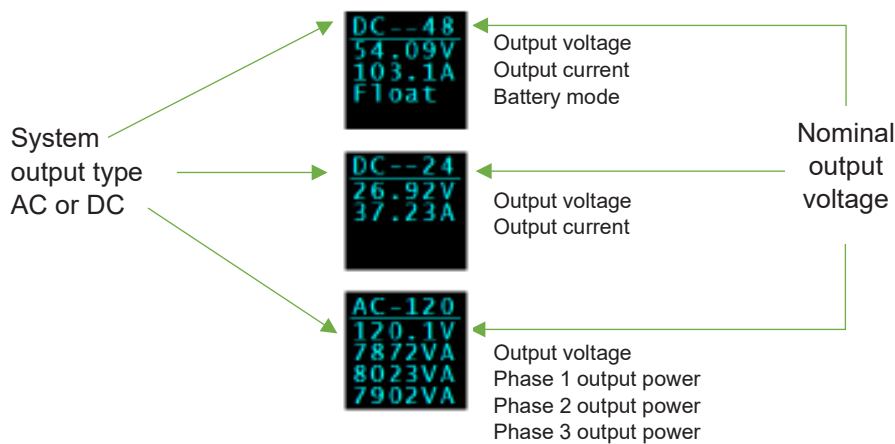

Figure 4: Cordex® CXCi HP controller menu

### 4.2.3 In-shelf display menu

From the OLED dashboard, use the Select button to enter a menu. From the menu, the OLED display lets you execute a set of commands much like the LCD on the 2RU Cordex® CXC HP controller.

When you enter a menu, the top item is highlighted. To go to another menu, scroll through using the **Forward** and **Back** buttons. To execute a highlighted menu item, select the **Select** button.

To exit a menu and return to the main dashboard, scroll to the **Back** command, and then select the **Select** button. The following table provides a full list of menus available via the in-shelf display.

Menu label	Description
<b>ALCO</b>	Perform the alarm cut-off command.
<b>Restrt</b>	Perform a software restart of the controller.
<b>IPv4</b>	Display the IPv4 address, subnet, and gateway for this controller.
<b>IPv6</b>	Display the IPv6 addresses assigned to this controller.
<b>AutoIP</b>	Set the IP to <b>Automatic</b> (obtained from the DHCP server).
<b>RstIP</b>	Reset the IP to <b>Static Default</b> (IP: 10.10.10.201, subnet: 255.255.255.0).
<b>Port</b>	Displays the port number for the controller.
<b>Backup</b>	Backup the controller application and configuration to a file on a USB drive.
<b>Resto</b>	Restore the controller application and configuration from a file on a USB drive.
<b>Upgra...</b>	Upgrade the controller application from a file on a USB drive.
<b>OS Upg</b>	Upgrade the controller's operating system from a file on a USB drive.
<b>Info</b>	Display controller information including serial number, part number, software, and hardware version.
<b>Rotate</b>	Rotate the in-shelf controller display information by 90 degrees.
<b>Explnv</b>	Export all inventory to USB drive. This is a large file and may take a while to export. The data can be used for analysis in a spreadsheet program.
<b>RemCfg</b>	When <b>Remote Configuration Lockout</b> has been enabled, this menu allows the lockout to be temporarily overridden for a pre-configured amount of time.
<b>Back</b>	Exit the menu and return to the dashboard.

## 4.2.4 In-shelf controller buttons

The following figure shows how the buttons are interpreted.

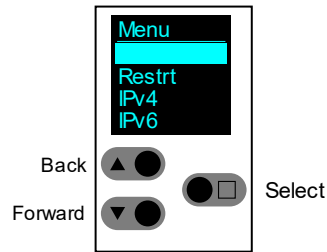

Figure 5: In-shelf controller buttons

## 4.2.5 Controller I/O

### Ethernet port

The Ethernet port is designed for connection to a user supplied network (TCP/IP secured by user) via a front panel RJ45 jack and a standard network cable. Local access (for example, a laptop computer) is also possible from the Ethernet port connection using a standard network cable.

### Network connection and remote communication

The Cordex® HP system can be set up, monitored, and tested via an Ethernet connection. The communication protocol supports a web interface. All alarming and control of the rectifiers is accomplished with a controller via CAN bus.

### USB port

A USB 2.0 port is located on the front of the controller. It is used for upgrading operating system software.

### 4.3 Shelf connections and indicators

Connections to alarms as well as load connections are conveniently located on the side of each shelf.

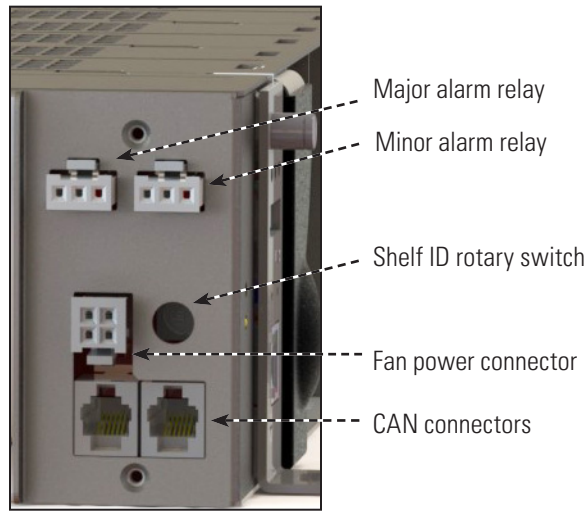

Figure 6: Shelf connections

#### 4.3.1 Alarm relays (Form C contacts)

The converter shelf has an interface panel with terminal blocks for major and minor alarm outputs (Form C contacts), which are controlled by the controller. The major alarm relay is designed as a fail safe to ensure the alarm is registered when power is removed.

##### Major alarm

The major alarm relay de-energizes under any one of the following conditions:

- Two or more outputs have failed within a shelf
- One -48 V input below 40 V
- One -48 V input is greater than -60 V

##### Minor alarm

The minor alarm relay is de-energized under any one of the following conditions:

- Single output failed within a shelf
- Internal ambient temperature out of range

##### Alarm LEDs

There are two LEDs – one red and one yellow, on the front of the interface panel, that indicate shelf alarm status, see [Figure 7](#).

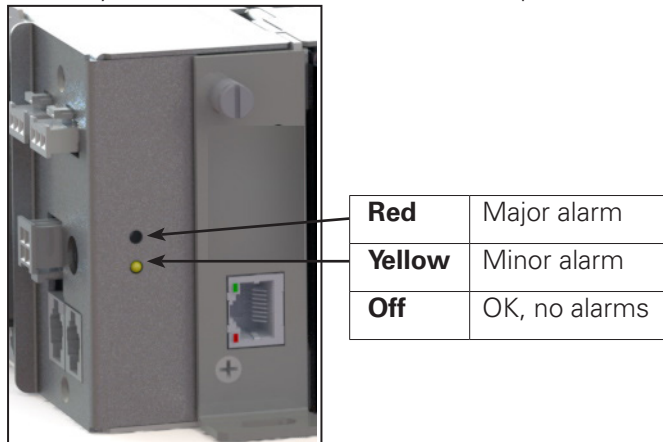

Figure 7: Shelf alarm LEDs

## 4.4 Shelf accessories

### 4.4.1 Fan tray and baffle tray

The optional fan tray and baffle tray are each 1RU high (see [Figure 8](#)). They are typically mounted together directly below the shelf assembly.

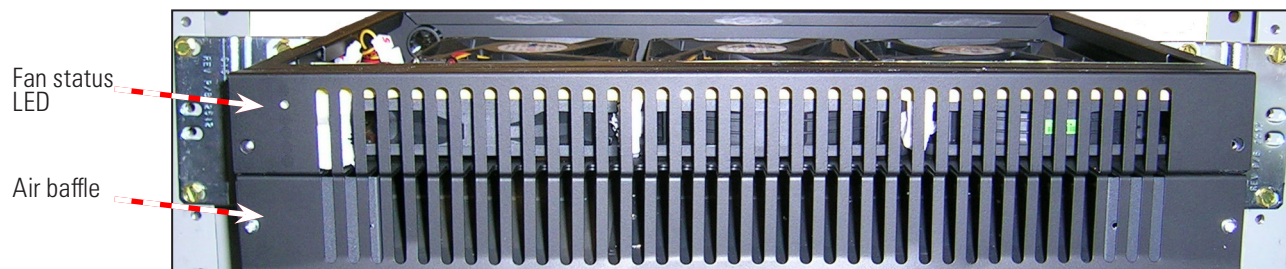

Figure 8: Fan and baffle tray rack mounted

The fan tray has six fans with a total minimum flow of 94.4 L/s (200 CFM). The fans are powered from the shelf directly above it. If any fan fails, a status LED on the front panel turns red. The fan tray also has a fail safe Form C fan fail alarm relay that can be connected to a local alarm-sending unit. (See [Figure 27](#).)

The following configuration is required to operate more than one and up to three shelves in the temperature range specified in the [Specifications](#) section.

- A fan tray and baffle mounted directly below the shelves.
- A rack space (1RU) for an air deflecting baffle mounted directly above the three shelves.

### 4.4.2 Mounting 19-inch equipment in a 23-inch rack

To mount a 19-inch shelf in a 23-inch rack, install the included 2RU universal mounting brackets

**PN: 5901456-002.**

To mount a 19-inch fan or baffle tray in a 23-inch rack, install the included 1RU universal mounting brackets

**PN: 5901456-001.**

### 4.4.3 Blanks

Blanks are available for unused slots. Order blanking plate kit (contains two blanks) **PN: 0380070-001.**



#### NOTICE

Install blanks in any unused slot to prevent air from escaping the space. The blank ensures air is forced through the modules for effective cooling of the shelf.

### 4.4.4 Alarm cable kit

Terminal blocks for major and minor alarms use Molex connector 39-01-4031. Kit **PN: 8700649-001** is available from Alpha Technologies Ltd. with one connector.

## 5. Inspection

---

### 5.1 Packing materials

EnerSys is committed to providing products and services that meet our customers' needs and expectations in a sustainable manner, while complying with all relevant regulatory requirements. As such EnerSys strives to follow our quality and environmental objectives from product supply and development through to the packaging for our products.

Rectifiers and batteries are shipped on individual pallets and are packaged according to the manufacturer's guidelines.

Almost all EnerSys packaging material is from sustainable resources and is recyclable.

### 5.2 Returns for service



#### **NOTICE**

**EnerSys is not responsible for damage caused by improper packaging of returned products.**

Save the original shipping container. If the product needs to be returned for service, it should be packaged in its original shipping container. If the original container is unavailable, make sure that the product is packed with at least three inches of shock-absorbing material to prevent shipping damage.

### 5.3 Check for damage

Before unpacking the product, note any damage to the shipping container. Unpack the product and inspect the exterior for damage. If any damage is observed, contact the carrier immediately. Continue the inspection for any internal damage. In the unlikely event of internal damage, inform the carrier and contact EnerSys for advice on the impact of any damage.

### 5.4 General receipt of shipment

The inventory included with your shipment depends on the options you have ordered. The options are clearly marked on the shipping container labels and bill of materials.

### 5.5 Miscellaneous small parts

Review the packing slip and bill of materials to determine the part number of the "configuration kits" included with your system. Review the bill of materials to verify that all the small parts are included. Contact Alpha Technologies Ltd. if you have any questions before you proceed.



## 6. System installation

---

This chapter is provided for qualified personnel to install the system and provides cabling details and notes on cable sizing for DC applications.

### 6.1 Installation location

This equipment is suitable for installation in one or more of the following locations:

- Network Telecommunication Facilities
- Locations where the NEC applies
- OSP

### 6.2 Pre-installation requirements

#### 6.2.1 Primary protection

The Cordex® HP eLimiter+ distribution system has built-in second level surge protection in compliance with the GR-1089 requirement. Primary protection must be in place at the customer site.

### 6.3 General instructions

Connections to the converter system must comply with all the local codes and ordinances.

### 6.4 Safety precautions

Before working with any live power system, take the following precautions:

- Remove all metallic jewelry; for example, watches, rings, metal rimmed glasses, and necklaces.
- Wear safety glasses with side shields (and prescription lenses if necessary) at all times during installation.
- Use OSHA approved insulated metallic tools.



#### **WARNING**

The DC input to the modules (and the converter system) – though not dangerous in voltage – has a high short circuit current capacity that may cause severe burns and electrical arcing.

The installer should follow all applicable local rules and regulations for electrical and battery installations; for example, CSA, UL, CEC, NEC, OSHA, and local fire codes.

### 6.5 Tools required

Various insulated tools are essential for product installation. Use the following as a guide:

- Phillips head screwdriver, #2 (tip size 3/16 inch)
- Slot head screwdriver (blade size 1/8 inch)
- Digital voltmeter equipped with test leads
- Cutters, crimpers, and wire strippers 0.25 to 16 mm<sup>2</sup> (24 to 6 AWG)

## 6.6 Setting the shelf ID

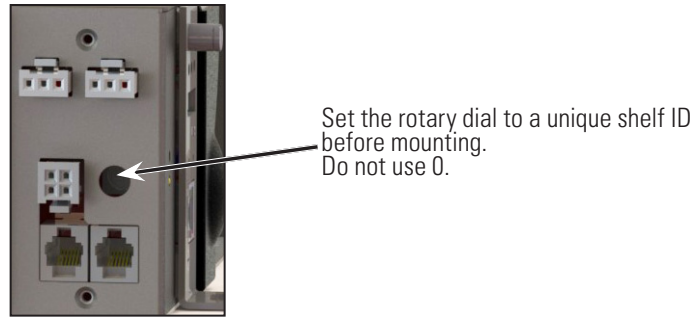

Figure 9: Setting the shelf ID

## 6.7 Rack mounting



### NOTICE

Use thread forming screws with paint piercing washers to connect the shelves and fan assembly to the frame.

Use universal mounting brackets to mount the Cordex® HP eLimiter+ shelf in a 19-inch or 23-inch rack. For bracket part numbers see section [Mounting 19-inch equipment in a 23-inch rack](#).

### 6.7.1 Thermal management with fan tray

If operating more than one contiguous shelf a fan tray is required. One fan tray can be used for up to three shelves. Three contiguous shelves require a fan tray and two baffles to meet the specified cooling requirements. Install the fan tray directly below the three converter shelves and a baffle tray below the fan tray. In addition, install a baffle tray above the converter shelves. Up to nine converter shelves can be installed in a rack, provided each three contiguous shelves has fan cooling.

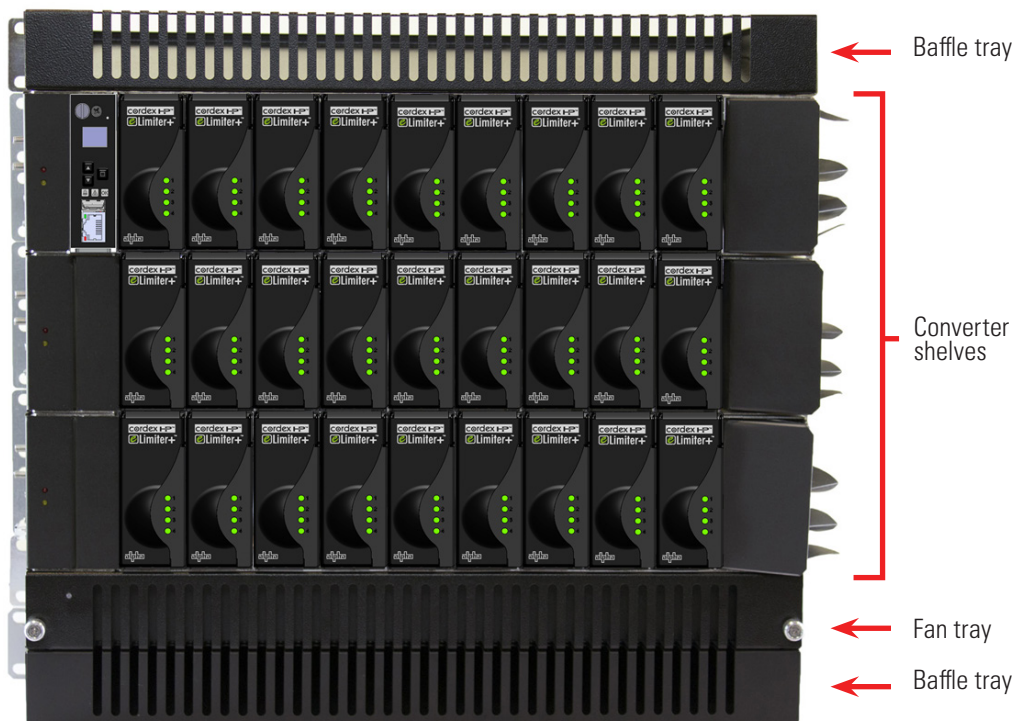

Figure 10: Multi-shelf system mounting



## ATTENTION

When the Cordex® HP eLimiter+ distribution system is operating normally at maximum rated load, the shelf level rate of heat dissipation exceeds the allowable limit of 27.9 W/sq.ft. as per Section 4.1.6 of GR-63-CORE (Issue 6).

We recommend leaving a minimum of 18.3 cm (7.2 in.) vacant vertical rack space for each 19-inch shelf installation to meet the required shelf-level rate of heat dissipation. To comply with this limit, additional empty vertical frame space must be added as shown in [Table B](#). In addition, special equipment room cooling may be required.

Table B — Vertical frame spacing requirements (NEBS GR-63-Core)

Installation type	Additional empty vertical frame space needed for compliance	Maximum number of EUT chassis able to be installed in 7 foot frame and maintain compliance
19-inch frame	73.5 cm (86.4 in.)	1

### 6.7.2 Thermal management without a fan tray

When installing the Cordex® HP eLimiter+ system without a fan tray, 3RU space is required for thermal management. Each shelf requires a 1RU air space, one baffle tray and then an additional 1RU air space, see [Figure 11](#).

Install the first converter shelf and then leave 1RU of air space directly above the converter shelf. Install a baffle tray above the air gap, and then leave 1RU of air space between the subsequent converter shelf.

Provide a minimum 7.6 cm (3 in.) air space between the floor and the bottom of the unit for ventilation.

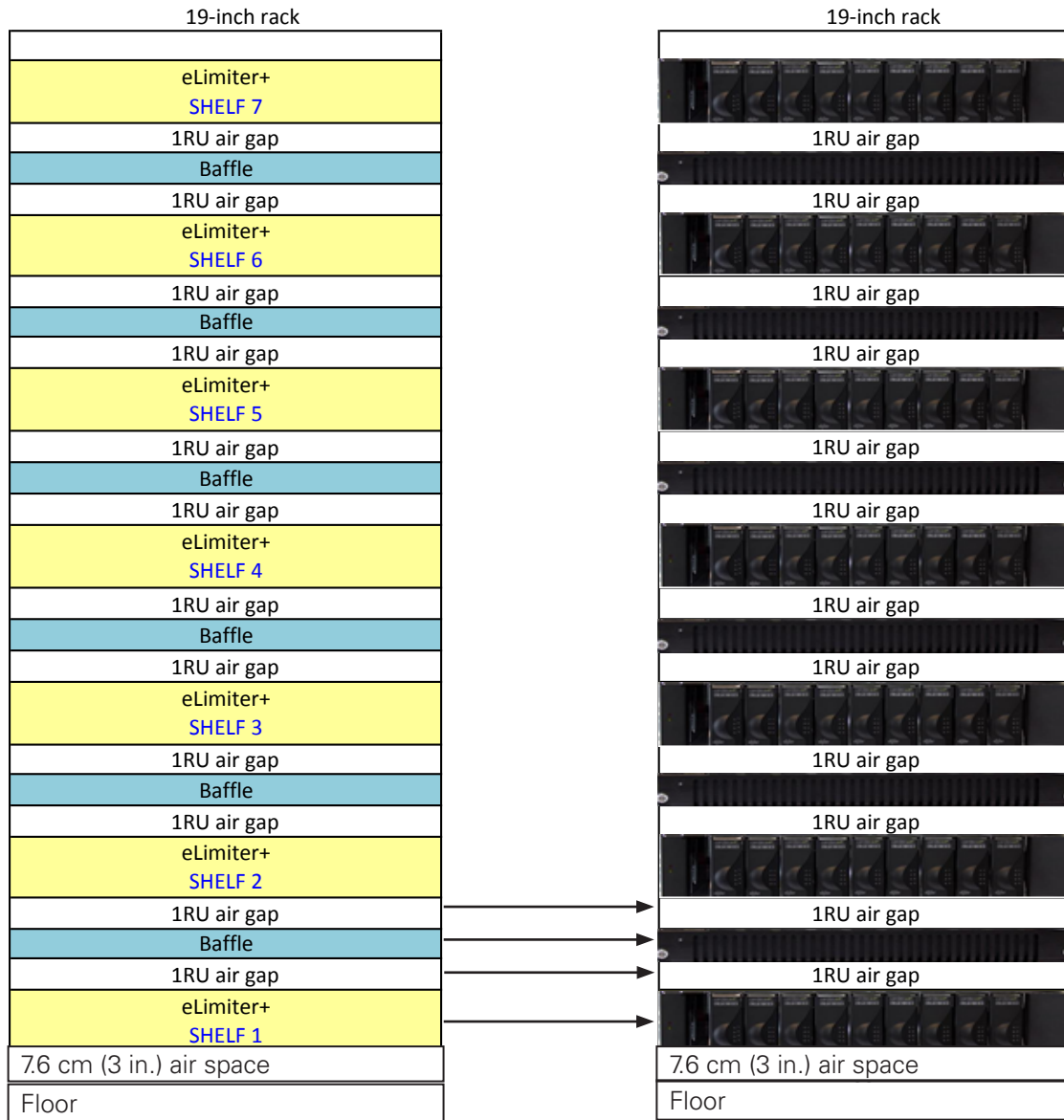

Figure 11: Thermal management without a fan tray

## 6.8 I/O wiring

This power system is suitable for installation as part of a Common Bonding Network (CBN) and is intended to be used in a DC-I configuration (isolated from frame ground).

This system is intended to be used with a –48 Vdc rectifier or battery system at the input.

### 6.8.1 Wiring chassis ground



#### GROUNDING

Ground connections are bright electro-tin plated class B as per ASTM B545-97 Class B. No antioxidant is required before crimp connections are made.

Protective earthing terminals are provided for chassis ground—two pair at the side and one pair at the rear (see [Figure 12](#)).

1. Connect the power system chassis to the building master ground bus (MGB). This connection is necessary for personnel safety and to meet many telco-grounding requirements.
2. Use minimum 16 mm<sup>2</sup> (6 AWG) copper wire and standard two-hole crimp lugs for #10 studs on 5/8 inch centers.
3. Secure the lugs with #10-32 serrated flanged nuts (supplied) to provide the anti-rotation necessary for primary ground connections.

Recommended torque values	
#10-32	5.1 Nm (45 in-lb)

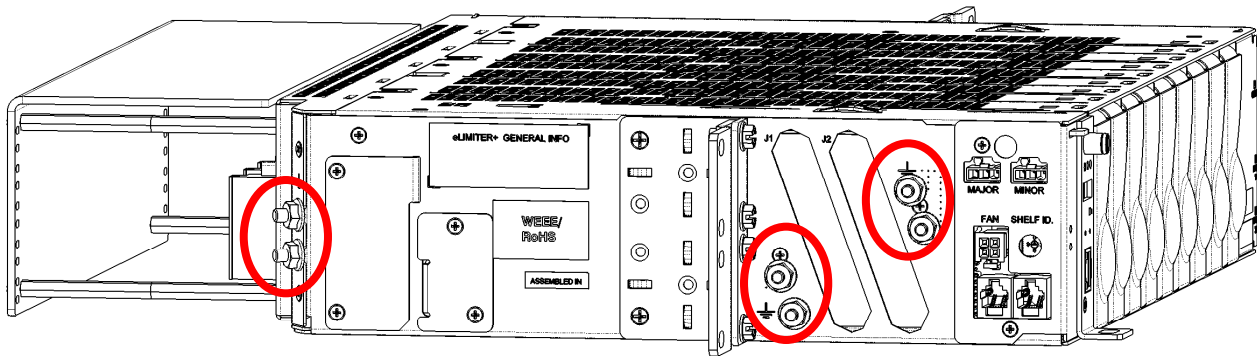

Figure 12: Locations for protective earthing terminals for chassis ground (side view)

### 6.8.2 Connect the DC input



#### NOTICE

Connect the Cordex® HP eLimiter+ system to a Safety Extra Low Voltage (SELV) <60 Vdc input power circuit.

Connections are provided for either front or rear access.

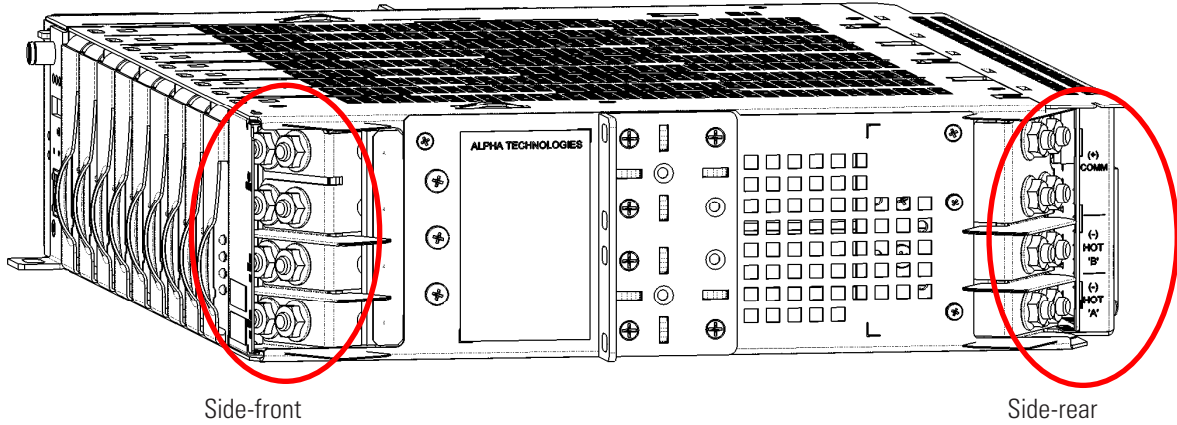

Figure 13: DC input connections



#### WARNING

Ensure input feeder breakers are off before connecting inputs. Hazardous voltages or energy levels are present at the input of power systems.

Each shelf has two negative inputs (A and B), and two connections to a positive common input. Half the converters are powered by Feed A and half by Feed B as listed in the following table.

We recommend that each converter shelf have two dedicated input feeder breakers, if both A and B feeds are used.

Refer to the [Specifications](#) section for recommended breaker and cable sizes. Local electrical codes take precedence.

Table C — DC input wiring connections

Shelf width	Feed A to converter slots	Feed B to converter slots
19-inch	1 to 5*	6 to 9*

\* Slots are numbered from left to right when viewed from the front.

¼ inch studs on 5/8 inch centers

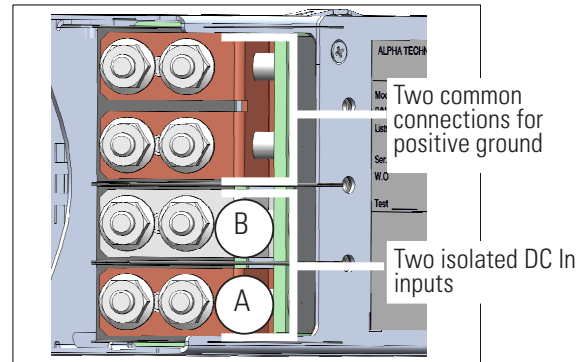

Figure 14: DC input wiring connections

### 6.8.3 Accessing the side-front input terminals

#### To use the front inputs

1. Remove the center screw on the side cover.

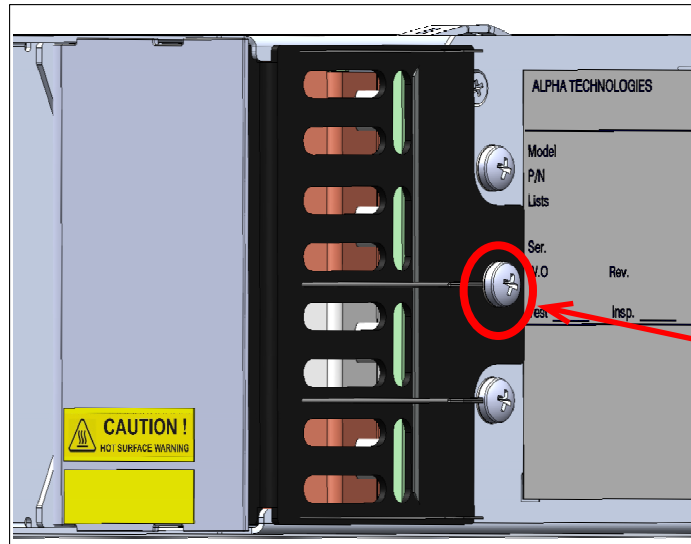

Figure 15: Remove the center screw

2. Pull the side cover about 3 mm (0.125 in.) towards the front and then move it to the side.
3. Pull the front cover forward to gain access to the input terminals and straighten the underlying black separators that were folded under the side cover.

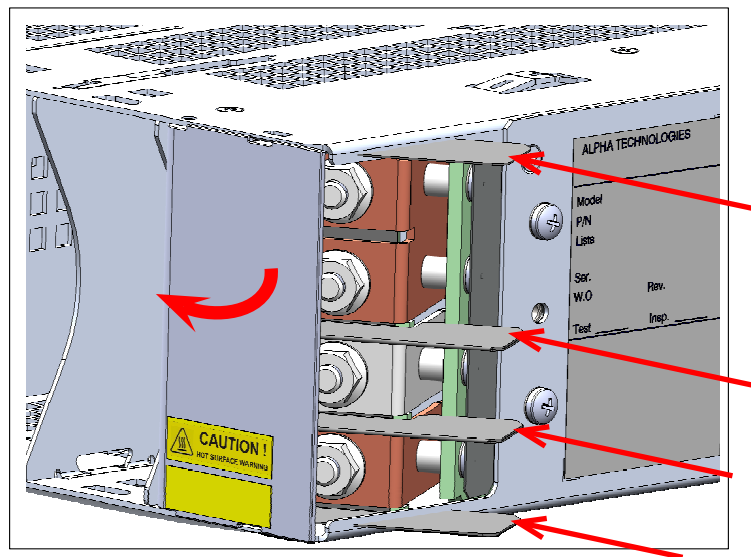

Figure 16: Formex separators between the inputs

4. Trim the side cover between the slots as required for the cables to fit through. See [Figure 17](#) and [Figure 18](#).



## ATTENTION

The cut out guidelines illustrated in [Figure 17](#) and [Figure 18](#) are for reference purposes only, the actual trimming should be performed in a manner to assure minimal clearance around the incoming cables relative to their specific size. Maintaining this minimal clearance (6.35 mm; 0.25 in.), will prevent accidental contact with the supply voltages and assure compliance with user accessibility requirements.

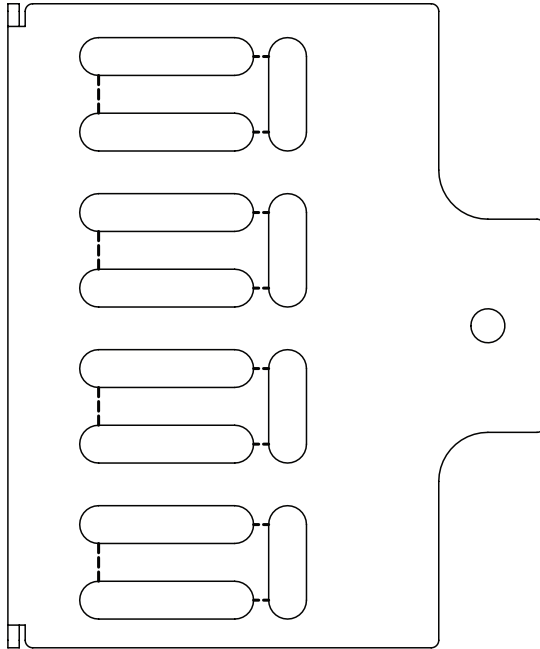

Figure 17: Cut lines for cable input

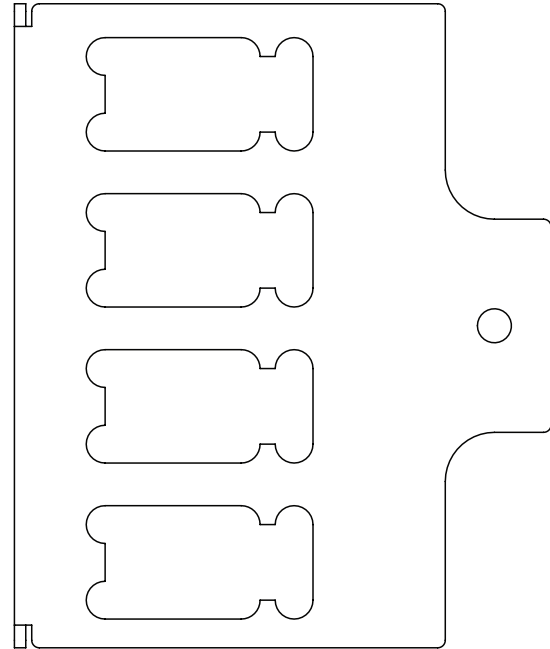

Figure 18: Cover cut complete

5. Push the cables through the newly created openings and install them on the input terminals.
6. For reinstallation, the front flap of the front cover should be installed before the side cover (the side cover locks the front cover in place).
7. When reinstalling the side cover the black Formex separators (shown in [Figure 16](#)), should poke through the new openings ([Figure 18](#)) in the cover along with the cables.



### 6.8.4 CAN bus connections

Each shelf and fan tray communicates with the controller using CAN protocol. The modules report alarms, converter output voltages, ambient temperature, and the location of the module within a cabinet.

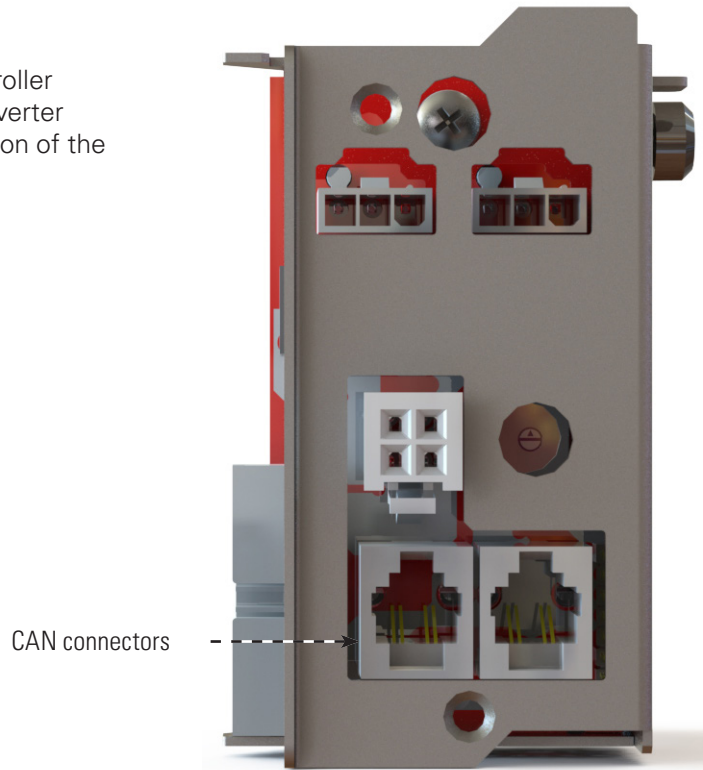

Figure 19: CAN connections on the shelf interface panel

1. Connect the daisy-chained CAN bus cable (PN: 877-176-44) from the top shelf to the last shelf or the fan tray. [Figure 20](#) shows the wiring for three shelves and a fan tray.
2. Insert the CAN terminator (PN: 5450228-001) in the last CAN OUT location.

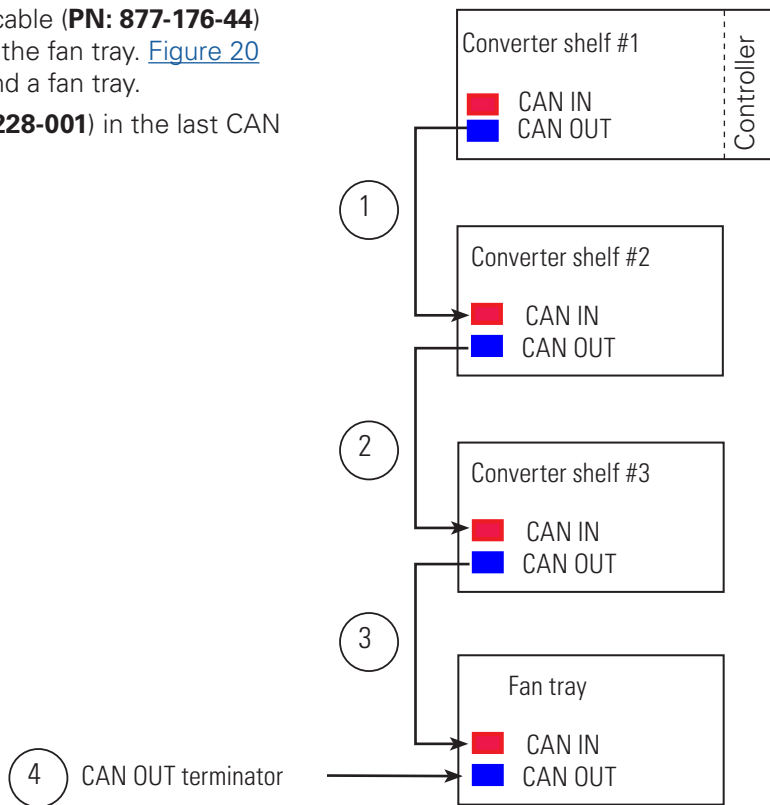

Figure 20: CAN bus cabling

### 6.8.5 Connect power to the fan tray

Power to the fans is provided by the converter shelf above it. Plug the cable from the fan tray into the receptacle labeled FAN PWR in the converter shelf above it.

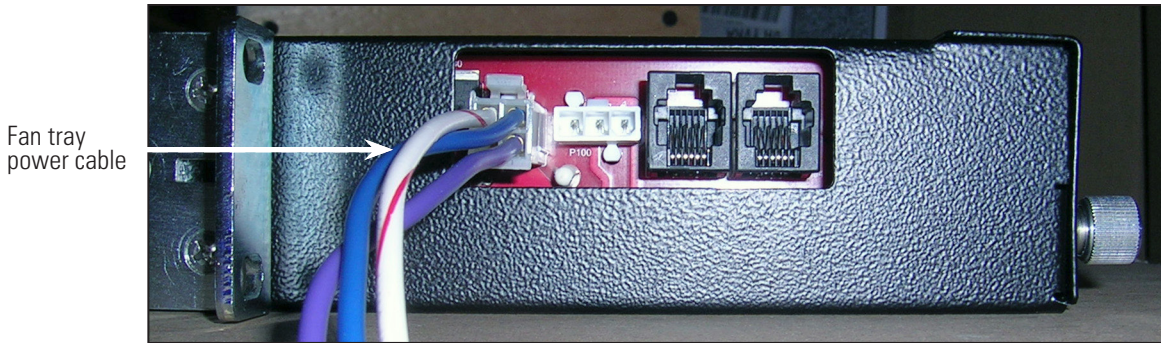

Figure 21: Fan tray connections

### 6.8.6 Load connections

Connections to the loads are made with terminal block connectors. Refer to the following figures for the connector pinout locations and the recommended load wiring connections.

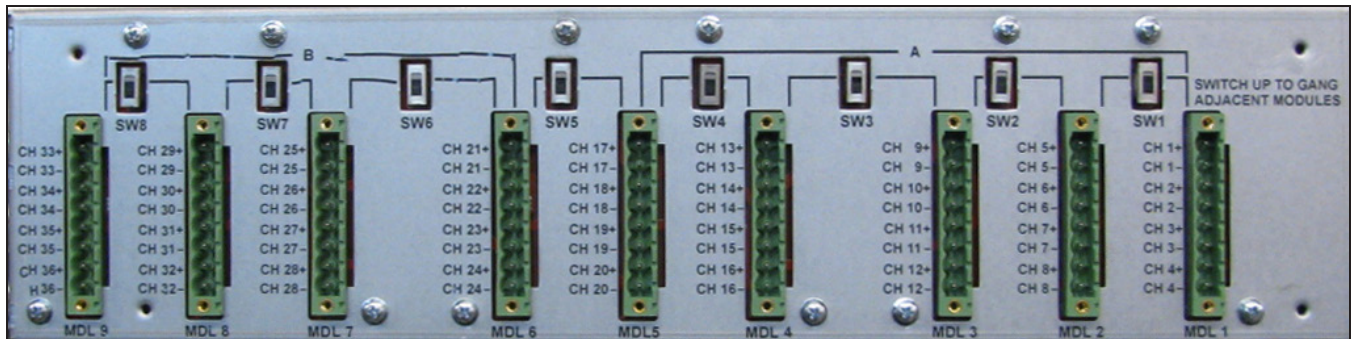

Figure 22: Terminal block and connector pinouts

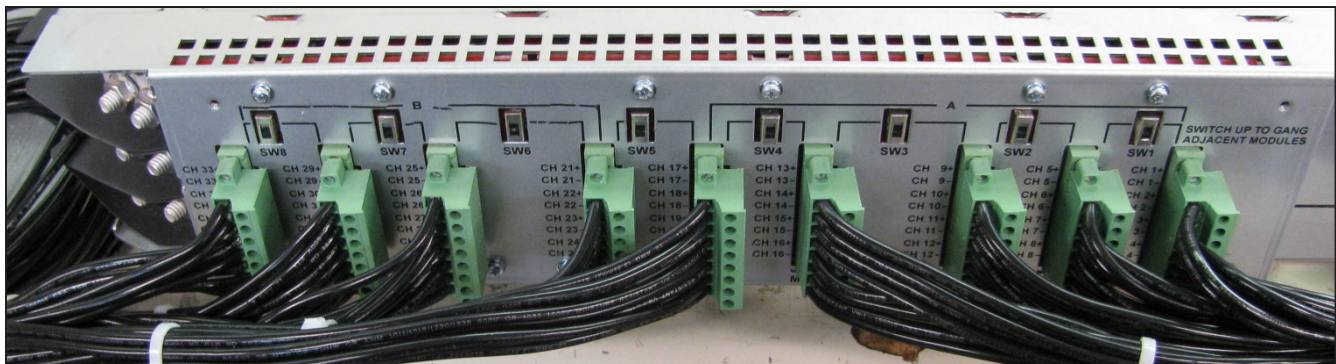

Figure 23: Recommended load wiring connections

### 6.8.7 Channel designation card

The Cordex® HP eLimiter+ distribution system comes with a blank channel designation card to physically label each channel. No special pen is required to write on this card.

	CH	DESCRIPTION	CH	DESCRIPTION	CH	DESCRIPTION	CH	DESCRIPTION	CH	DESCRIPTION
	1		9		17		25		33	
	2		10		18		26		34	
	3		11		19		27		35	
	4		12		20		28		36	
SHELF ID #	5		13		21		29		MODULES GANGED TOGETHER	
	6		14		22		30		1	2
	7		15		23		31		3	4
	8		16		24		32		5	6
										7
										8
										9
										9500428-001 REV. A

Figure 24: Channel designation card

Fill in the card, and then insert in between the most right converter slot and the cover protecting the DC input connections for safe storage as illustrated in [Figure 25](#).

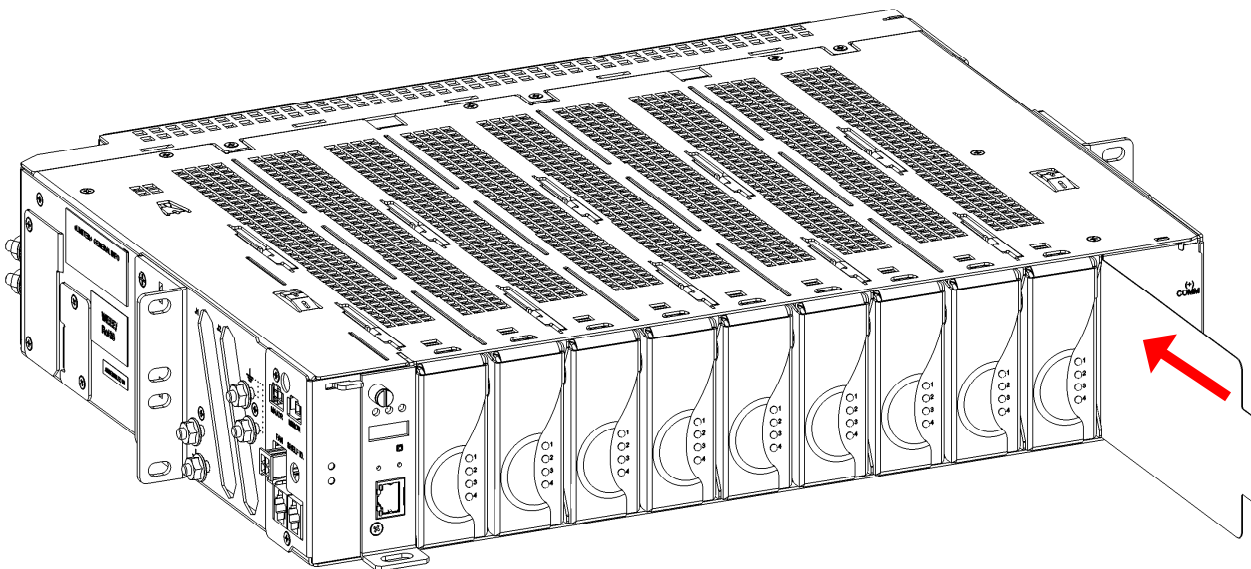

Figure 25: Inserting the channel designation card

## 6.9 Wiring the alarm relays

### 6.9.1 Converter shelf

Two Form C relay contacts are available for **Major** and **Minor** alarms.

Connect the relays (located on the side of the controller-side of the shelf) to the local alarm-sending unit using wire gauges from 0.08 to 1.31 mm<sup>2</sup> (28 to 16 AWG). The NO/C/NC positions for each alarm are shown in [Figure 26](#).

Outputs from the alarm relays can be ganged to produce one alarm at the alarm-sending unit.

<b>Note:</b>	Terminal blocks for major and minor alarms use Molex connector 39-01-4031. <b>PN: 8700649-001</b> is available with one connector.
--------------	--

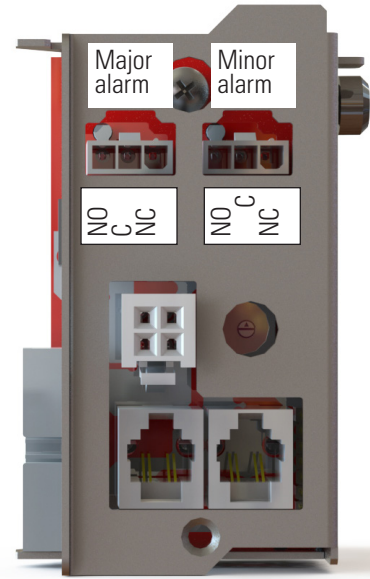

Figure 26: Converter shelf alarm relays

### 6.9.2 Fan tray

Use wire gauges from (0.08 to 1.31 mm<sup>2</sup> (28 to 16 AWG)

The NO/C/NC positions for each alarm are shown in [Figure 27](#). Failure of a fan generates a **Major** alarm.

The Form C relay, on the side of the fan tray, can also be connected to the local alarm-sending unit.

Outputs from the alarm relays can be ganged to produce one alarm at the alarm-sending unit.

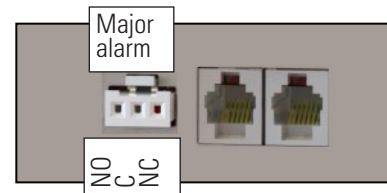

Figure 27: Fan tray alarm relay



### 6.9.3 Group reset configuration

The group reset configuration is used to synchronize the start up or reset of multiple modules (more than four outputs). Group reset is used in case of fault conditions so that all outputs recover at the same time. Up to nine modules can be configured in a daisy chain wiring scheme.

To use a group reset, enable the switch links from the modules.

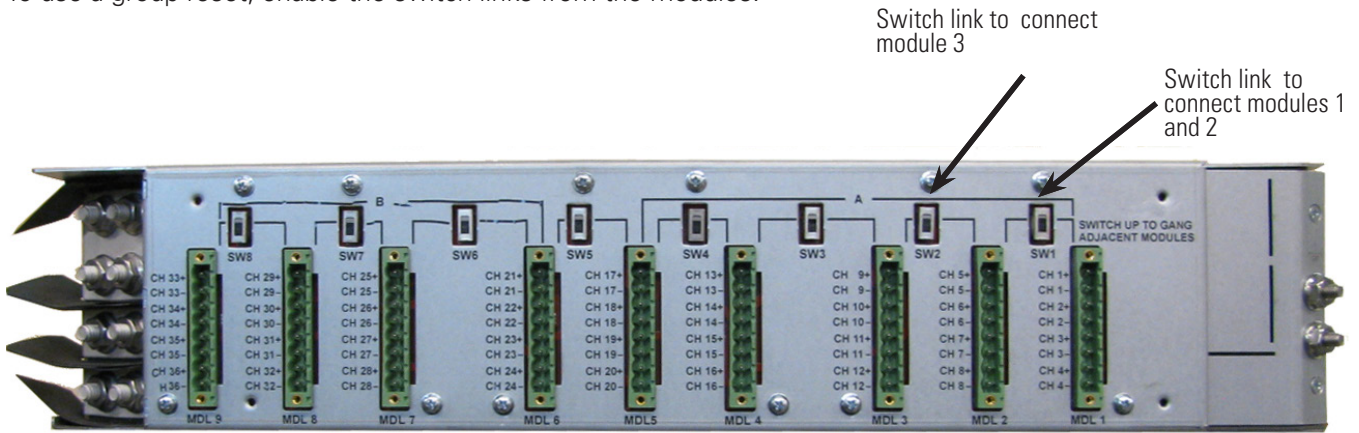

Figure 28: Group reset switches

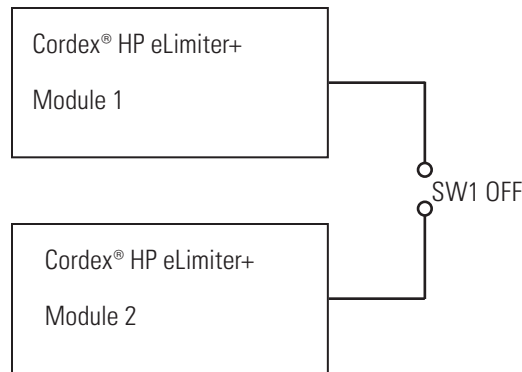

Figure 29: Default setting, independent outputs

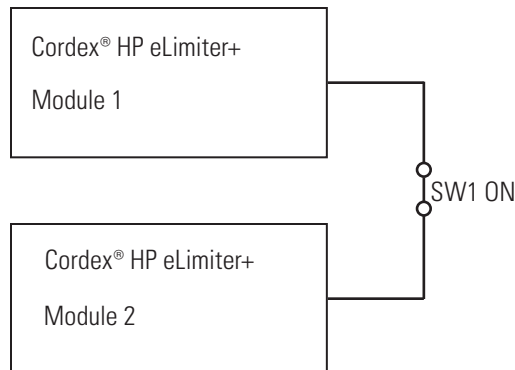

Figure 30: Group reset enabled

## 6.10 Installing the controller and converters

The Cordex® CXCi HP controller and converters ship as separate items and are installed after mounting the Cordex® HP eLimiter+ shelf.

### 6.10.1 Installing the Cordex® CXCi HP controller

#### Step 1:

Loosen the thumbscrew and remove the blank panel.

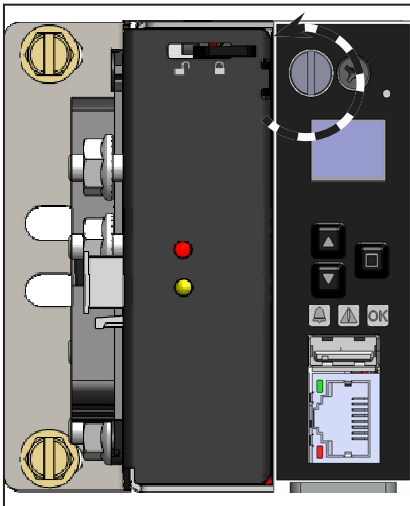

#### Step 2:

Slide the locking tab to the left.

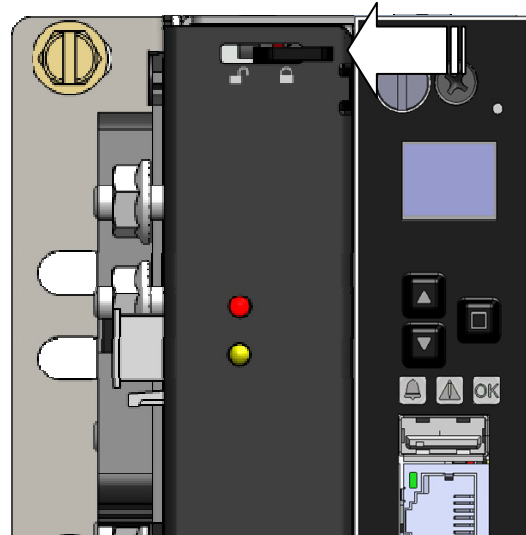

#### Step 3:

Slide the controller straight into the connector at the rear of the slot.



#### Step 4:

Slide the locking tab to the right.

Tighten the thumbscrew with a screwdriver.

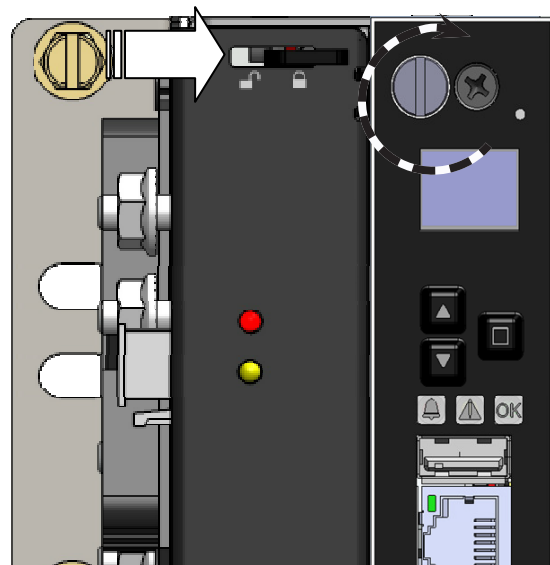

## 6.10.2 Installing the converters

1. Populate the shelf sequentially starting from the slot closest to the controller or controller blanking plate.
2. Slide the module into the slot with the handle in a closed position. Some additional pressure may be required to engage the card edge connector at the rear of the shelf.
3. If the module handle is caught on the dividers between slots, apply some slight pressure away from the divider as indicated by arrow **1**, as indicated in the top view, while continuing to move the module into the slot as indicated by arrow **2**, also indicated in the top view figure.

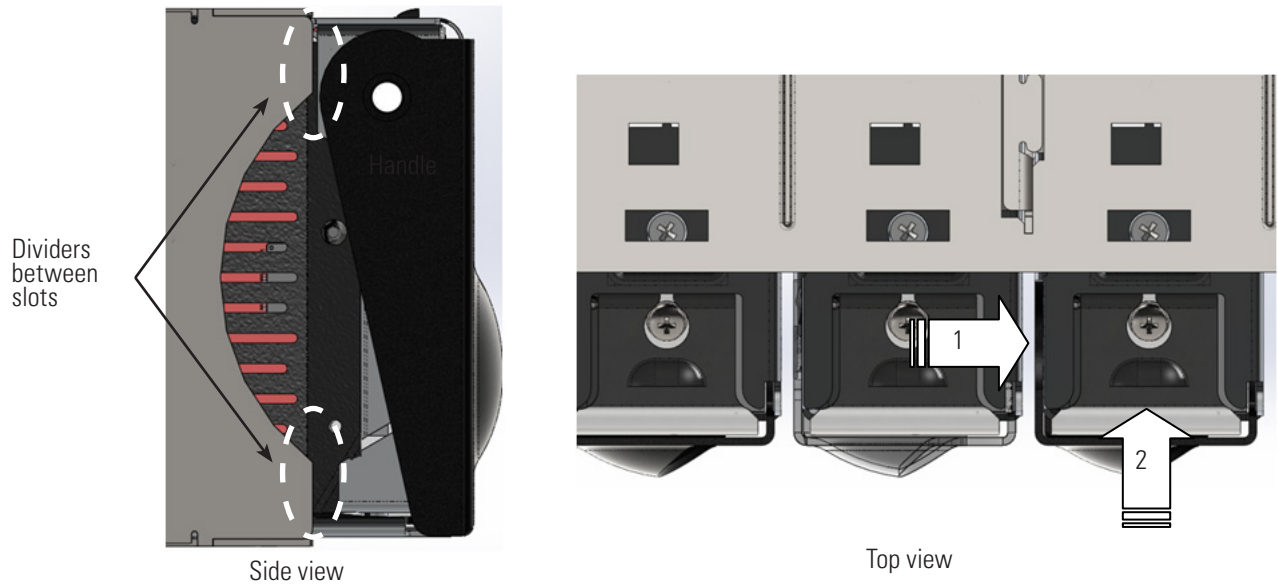

Figure 31: Installing converters

### 6.10.3 Installing the back cover and securing the wires

Once the recommended load wiring connections are complete secure the wires with cable ties, as in [Figure 32](#) and then install the back cover as seen in [Figure 33](#).

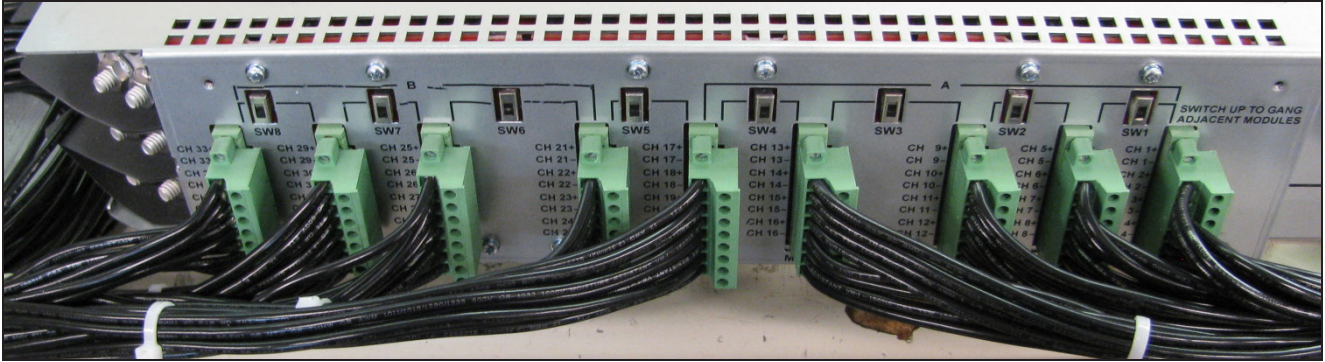

Figure 32: Securing the wires

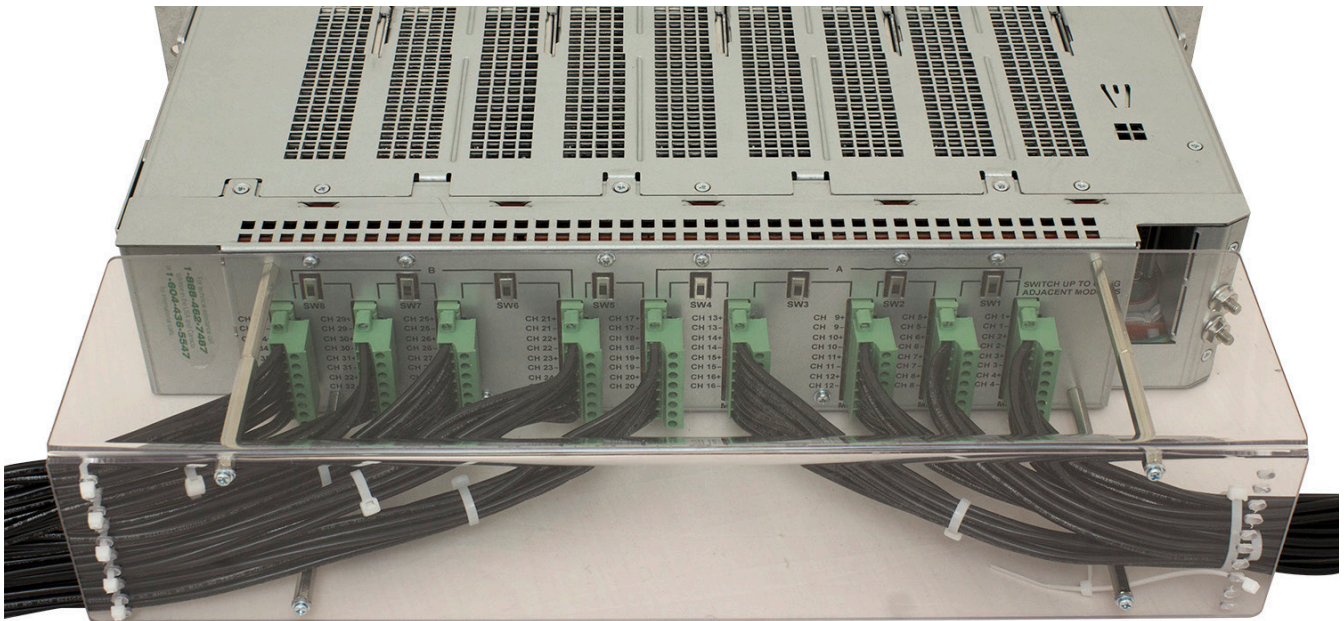

Figure 33: Installing the back cover



## 6.11 System startup

To ensure proper operation, perform the following startup and test procedure after completing the system installation wiring.

### 6.11.1 Procedure

To meet the GR-1089-CORE requirement, the Ethernet cable shall be a maximum of six meters (19.7 feet) in length.

<input type="checkbox"/>	Start with DC input breakers off.
<input type="checkbox"/>	Install the controller into the left most position.
<input type="checkbox"/>	Install the converters in the slots.
<input type="checkbox"/>	Turn on the DC breakers.



Controller      Converter

### Parameter setup

<input type="checkbox"/>	Reset the controller (front reset button) to set network IP parameters to factory default: <ul style="list-style-type: none"> <li>• <b>IP address:</b> 10.10.10.201</li> <li>• <b>Subnet mask:</b> 255.255.255.0</li> </ul>
<input type="checkbox"/>	Connect a laptop to the controller with an Ethernet cable.
<input type="checkbox"/>	Edit the laptop IP network settings: <ul style="list-style-type: none"> <li>• <b>IP address:</b> 10.10.10.202</li> <li>• <b>Subnet mask:</b> 255.255.255.0</li> </ul>
<input type="checkbox"/>	Open a web browser and enter 10.10.10.201 in the web address bar.
<input type="checkbox"/>	Sign in to the controller: <ul style="list-style-type: none"> <li>• <b>Username:</b> admin</li> <li>• <b>Password:</b> admin</li> </ul>
<input type="checkbox"/>	Language selection: English
<input type="checkbox"/>	Go to <b>Controller &gt; Date &amp; Time</b> to set correct date and time.
<input type="checkbox"/>	Select Line <b>Powering System &gt; View Live Status</b> to display a graphical view of all acquired LPS devices. Selecting an LPS module displays a pop-up window with information specific to that LPS module and its channels. <p><b>Note:</b> If red text displays saying, <i>Invalid Shelf IDs have been detected!</i> or <i>Duplicate Shelf IDs have been detected!</i> the rotary dials to set shelf IDs have not be set up correctly.</p>
<input type="checkbox"/>	Sign out.

## 6.12 Summary of controller software



### NOTICE

Refer to the Line Power Systems chapter of the **Cordex® CXC HP Controller Software Manual (User Guide ID: 0350058-J0)** for controller functionality.

Menu item **Line Powering System > View Live Status** displays a graphical view of all acquired devices:

- Shelf ID
- Slot ID
- Per-channel information (output voltage and output current)

A tabular view can be accessed by selecting the **Switch to Table View** link. This can be useful if there are shelf ID conflicts which prevent the modules from showing in the graphical view.

Selecting a row displays a pop-up window with information specific to that Cordex® HP eLimiter+ module and its channels.

The icon in the **Startup/Shutdown** row indicates whether the LPS channel is powered **ON** (green) or **OFF** (black). Selecting a green icon for a particular channel commands the module to turn the output of that channel **OFF**.

Selecting a black icon commands the module to turn the output of that channel **ON**.

The module **Startup/Shutdown** icon is used to turn all four of modules **ON** or **OFF** at the same time.

If the **Group Reset** switch has been enabled, then the grouped modules will follow the same state as the modules that are being remotely controlled.



### NOTICE

If the Cordex® HP eLimiter+ modules are swapped quickly after acquired by the controller, the logical position in the user interface is not automatically updated to match the new slot position. To prevent this from happening, leave the eLimiter+ modules disconnected for long enough for the controller to detect they are missing (wait for the **LPS Comms Lost** alarm to be raised) before swapping them. In the event that the module position is not updated for any reason, an inventory update on the UI or a soft reset on the controller will solve the issue.



### NOTICE

The remote **Startup/Shutdown** feature using the controller is not a direct replacement for main power switch. This feature is mainly used to facilitate the reset of any latched channel, to temporarily enable or disable the channel, to synchronize restart of all group channels, or to clear any fault on the module.

When the channel or module is in shutdown mode, cycling the input supply (by unplugging the module or by power removal) will make the channel or converter active again when power is restored.

Therefore, the remote **Shutdown** should never be relied upon for powering off the device for safety purposes - for example, during maintenance activities. Due to power line fluctuations, module swapping, or up-stream maintenance work, it is possible that the equipment could re-start without warning after a remote shutdown is used."

## 6.13 Cordex® HP eLimiter+ channel grouping

The Cordex® CXCi HP controller has the capability of “grouping” eLimiter+ channels. This functionality is provided for the user’s convenience in displaying only, and does not correspond to any behavior on the modules themselves. It might be useful for users to set their grouping to match the **Group Reset** wiring that they have put into place on the back of the modules themselves.

On the **Line Powering System > Configure Groups** page, groups can be added, removed, and renamed. In addition, channels can be added to the groups by selecting the corresponding check boxes in the graphical view there. The group that a channel belongs to will be visible and editable from this page, and also on the module information pop-up page. In addition, the groups are displayed along the right-hand side of the page in the **Graphical Live View**.

If a user selects on the group name, the channels belonging to this group will be highlighted on that page.

## 6.14 Cordex® HP eLimiter+ channel custom text

The controller provides the user two custom text fields per eLimiter+ channel. These can be used to store information such as customer name or address where the channel output is directed, or any other information the user would like to associate with the channel.

The custom text can be viewed or edited from the module information page. In addition, there is a **Line Power System > Custom Text View** where the custom text and group information can be viewed all in one place. The groups and custom text can be edited on this page, and sorted to find all channels belonging to the same group, or with the same custom text.



### NOTICE

Groups and the custom text are saved on the controller against the channel location (shelf ID, slot ID, and channel), not against the serial number of the unit itself. Therefore, if a unit is swapped or replaced, the information will still be saved against the same location.

## 6.15 Cordex® HP eLimiter+ alarms

You can view the live status and configure alarms from the controller.

The LPS and channel alarms are indicated on the **Line Powering System > View Live Status** interface.

LPS alarms report in **Alarms > View Live Status, Alarms > Configure Alarms**, and **Event Log** interfaces.

The controller “rolls up” LPS alarm events. For example, if there are multiple LPS devices and one of them on one channel reports *Vout Low*, the alarm *LPS Channel Vout Low* is raised.

If a channel on a different LPS, also reports the same alarm, another distinct alarm will not be raised – it is “rolled up” into a single event.

### 6.15.1 Controller reset



#### NOTICE

Ensure that a backup has been performed before starting this process. Use the Backup feature accessed through the LCD at **Shortcuts > Backup**.

When the controller is being reset, the DC output voltage is maintained. Temperature compensation, user inputs, and relay controls are not available until the controller has finished restarting.

#### Soft reset

1. From the main dashboard, go to **Controller > Controller Status**.
2. Select the **Reset Controller** button.  
The **Controller Restart** window displays progress via a blue bar.
3. The controller screen goes black, and the LEDs lights cycle while restart is in progress.

#### Hard reset

A hard reset of the controller can be performed by selecting the front panel hard reset button. This procedure will restart the microprocessor if the controller soft reset fails to operate.

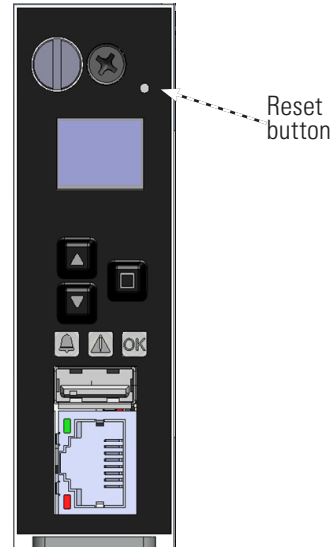

#### ATTENTION

Use of hard reset may cause loss of data.

## 7. Maintenance and troubleshooting

Although very little maintenance is required with Alpha® systems, routine checks and adjustments are recommended to ensure optimum system performance. Only qualified service personnel should do the repairs.



### WARNING

Use extreme care when working inside the unit while the system is energized. Do not make contact with live components or parts.



### ATTENTION

Circuit cards, including semi-conductor devices, can be damaged by static electricity. Always wear a grounded wrist strap when handling or installing circuit cards.



### ATTENTION

Ensure redundant modules or batteries are used to eliminate the threat of service interruptions while performing maintenance on the system's alarms and control settings.

The following table lists a few maintenance procedures for this system. These procedures should be performed at least once a year.

Table D — Sample maintenance log

Procedure	Date completed
Clean ventilation openings.	
Inspect all system connections. Re-torque if necessary.	
Verify alarm and control settings.	
Verify alarm relay operation.	

### 7.1 Fan tray replacement

The fan tray must be replaced by a qualified technician. The maintenance interval for a fan tray is five years at 30°C (86°F). It is replaced as a single unit. Individual fans are not replaceable. The procedure will take approximately five minutes and the system performs uninterrupted during this process.

1. Unplug power cable and remove signal wiring, if applicable (shown in **1**).
2. Loosen the two front panel screws (shown in **2**) and slide assembly forward to remove.
3. Replace with new assembly.
4. Plug the power cable back in and then attach signal wiring if applicable.

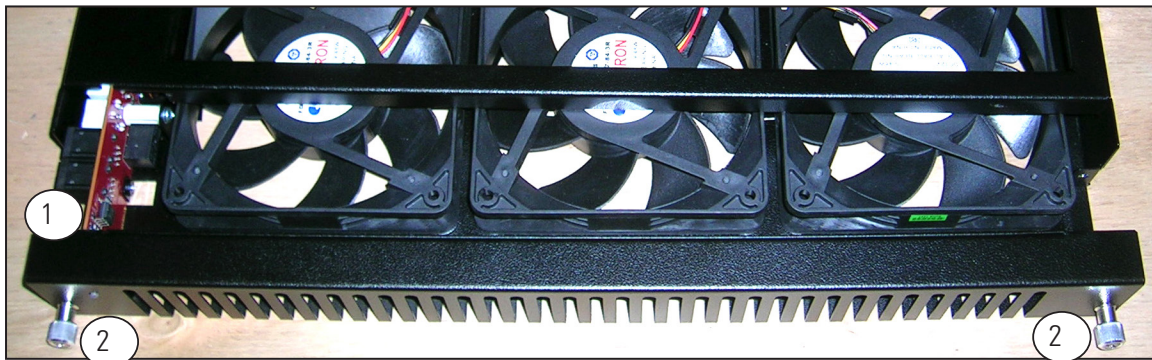

## 7.2 Troubleshooting Cordex® HP eLimiter+ status LEDs

### 7.2.1 Card alarms (all four LEDs)

LED state	Individual converter status	Action
Green	Normal	None
Blinking green	Remote shutdown enabled on whole module	Can be reset by toggling module or card <b>Startup/Shutdown</b> button through the controller.
	Shelf is not compatible with the module	Ensure that the shelf is correct. <b>Note:</b> Slots for the Cordex® HP eLimiter+ and LPS36 shelves are mechanically identical and the modules can be interchanged.
	Module not seated properly	Re-seat module
Yellow	<b>Recoverable:</b> Ambient temperature high	Resets automatically when ambient temperature reduces to approximately 85°C (185°F) or below.
Blinking yellow	Input quality not OK	Output is disabled if input voltage is not within the range of 40 to 60 Vdc.
OFF	<b>Recoverable:</b> No power	Check input wiring.
	<b>Non-recoverable:</b> Main input fuse cut-off	Potential component failure. Replace with new module.
Chasing green pattern	<b>Non-recoverable:</b> Group reset function not working	Hardware failure. Replace with new module.
Chasing red and green pattern	Locate feature enabled	None

### 7.2.2 Individual channel alarms

LED state	Individual converter status	Action
Green	Normal	None
Blinking green	Remote shutdown enabled on individual channel or converter.	Can be reset by toggling <b>Startup/Shutdown</b> button through the controller.
Blinking yellow	<b>Recoverable:</b> OCP/Overload	Ensure the load is within rated current.
	<b>Non-recoverable:</b> Converter input fuse fail	Potential component failure. Replace with new module.
Red	<b>Locked-state:</b> OVP	OVP latch can only be reset by removing and reinstalling the module or using the remote reset function through the controller.
	<b>Non-recoverable:</b> Converter output fuse fail	Failed fuses are not field replaceable. Replace with new module.
Blinking red	<b>Non-recoverable:</b> Secondary sensory fail	Potential failure on current sensor. Replace with new module.

## 7.3 Troubleshooting the fan tray status LED

LED state	Module status	Action
Green	Normal	None
Blinking green	Ambient temperature <20°C (68°F)	None
Yellow	<b>Recoverable:</b> Ambient temperature high	Resets automatically when ambient temperature reduces to approximately 85°C (185°F) or below.
Blinking yellow	<b>Recoverable:</b> Input voltage out of range (high or low)	Fan operation is disabled if input voltage is not within the range of 40 to 60 Vdc.
	<b>Non-recoverable:</b> Fan voltage low	Possible component failure. Replace the fan tray.
Red	Fan fail	Replace the fan tray.

## 7.4 Service kits

Part	Part number
Blanking plate kit (quantity: 2)	0380070-001
Alarm relay replacement kit	0380148-001 (includes PCB and bracket)
Fan input power cable	8700590-001
CAN bus terminator	5450228-001
Fan tray replacement assembly (19-inch)	0300055-004
Fan filter kit	0380256-001
DC input cover kit	0380249-001
Alarm relay cables (6 feet)	8700649-001



## 7.5 Replacing the controller

Undo the locking screw on the front of the controller until it clears the locking mechanism.

Slide the locking mechanism towards the unlock symbol.

Remove the controller.

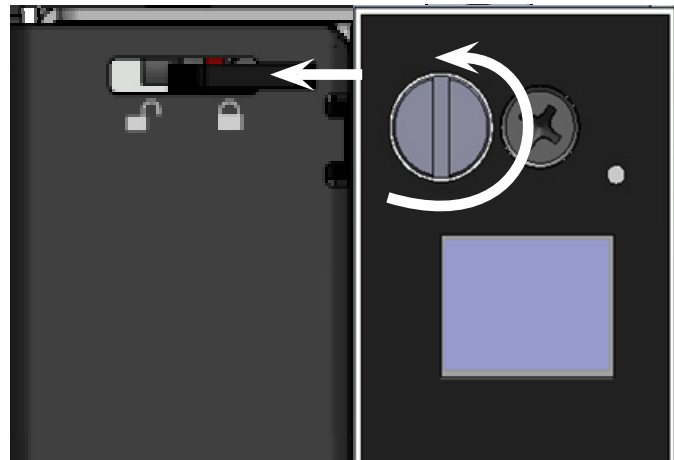

## 7.6 Replacing the Cordex® HP eLimiter+ modules

Cordex® HP eLimiter+ modules are plug and play. When a module is added to the system, the controller will detect and update the inventory automatically.

Replacing an installed Cordex® HP eLimiter+ module requires a manual **Inventory Update** at the controller web interface to clear the removed module from its current list of converters.

1. Connect a laptop to the controller with an Ethernet cable.
2. Edit the laptop IP network settings:
  - **IP address:** 10.10.10.202
  - **Subnet mask:** 255.255.255.0
3. Open a browser and enter 10.10.10.201 in the web address bar.
4. Sign in to the controller:
  - **Username:** admin
  - **Password:** admin
5. Go to **Modules > Forget Power Modules** in **Comms Lost**.

## 7.7 Replacing an alarm relay

The following procedures cover how to replace an alarm relay for shelves with or without a controller.

### 7.7.1 Alarm relay replacement for a shelf with or without a controller

The system is operational even without the controller during the alarm relay interface board change.



1. Remove the controller using the steps for [Replacing the controller](#).
2. Leave the locking tab in the 'unlock' position (pushed all the way to the left).
3. Unscrew the two screws shown in a counterclockwise direction, using a Phillips screwdriver.  
**Note:** Keep the screws for the replacement kit.



- Remove the two screws and then slowly slide the entire interface bracket out for about 5 cm (2 in.). At this distance, the ribbon cable (not shown) should still maintain some slack.

Outlined is part of the fan tray power cable (for reference) it may or may not to be connected depending on the required system setup.

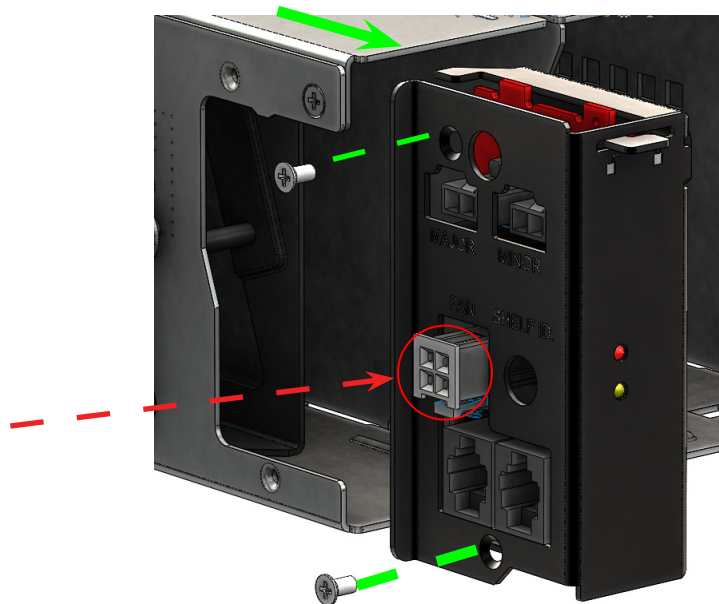

- Carefully disconnect the female end of the 20-pin ribbon cable from the male-end socket. The 20-pin connectors are directional, so you can only place it in one way due to the notch on the male-end and tab design on the female-end.

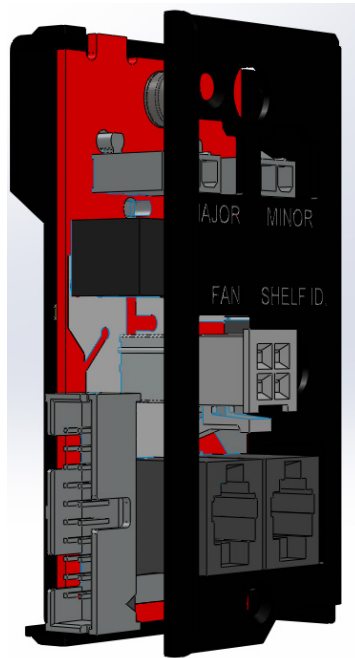

- Insert the new interface (**PN: 0380148-001**) and reverse the instructions. Make sure that the ribbon cable maintains some slack during the pin connection.
- Re-insert the controller (if applicable).

## 8. Acronyms and definitions

<b>AC</b>	Alternating current
<b>ANSI®</b>	American National Standards Institute
<b>AWG</b>	American Wire Gauge
<b>BTU</b>	British thermal unit
<b>CAN</b>	Controller area network
<b>CEC</b>	Canadian Electrical Code
<b>CPH</b>	Central power hub
<b>CX</b>	Cordex® series; CXC for Cordex controller
<b>DC</b>	Direct current
<b>DHCP</b>	Dynamic Host Configuration Protocol
<b>EIA</b>	Electronic Industries Alliance
<b>EMC</b>	Electromagnetic compatibility
<b>EMI</b>	Electromagnetic interference
<b>ERM</b>	Electromagnetic Compatibility and Radio Spectrum Matters
<b>ESD</b>	Electrostatic Discharge
<b>FCC</b>	Federal Communications Commission (for the US)
<b>GFCI</b>	Ground fault circuit interrupter
<b>HVSD</b>	High voltage shutdown
<b>IEC</b>	International Electrotechnical Commission
<b>IEEE®</b>	The Institute of Electrical and Electronics Engineers, Inc.
<b>IP</b>	Internet Protocol
<b>LED</b>	Light emitting diode
<b>LFM</b>	Linear feet per minute
<b>LPS</b>	Line Power System
<b>LVD</b>	Low voltage disconnect
<b>LVBD</b>	Low voltage battery disconnect
<b>MIL</b>	One thousandth of an inch; used in expressing wire cross sectional area
<b>MOV</b>	Metal oxide varistor
<b>MTBF</b>	Mean time between failures
<b>NC</b>	Normally closed
<b>NEC®</b>	National Electrical Code® (for the US)
<b>NO</b>	Normally open
<b>OSHA</b>	Occupational Safety and Health Administration
<b>OSP</b>	Outside Plant
<b>OVP</b>	Over voltage protection
<b>RFT circuit</b>	Remote feeding telecommunication circuit: A secondary circuit within the equipment, intended to supply or receive DC power via a telecommunication network at voltages exceeding the limits for TNV circuits, and on which overvoltages from telecommunication networks are possible.
<b>RFT-V circuit</b>	An RFT circuit, which is so designed and protected that under normal operating conditions and single fault conditions, the voltages are limited and the accessible area of contact is limited.
<b>RU</b>	Rack unit (44.45 mm; 1.75 in.)
<b>TCP/IP</b>	Transmission Control Protocol / Internet Protocol
<b>THD</b>	Total harmonic distortion
<b>TVSS</b>	Transient Voltage Surge Suppressor
<b>UL®</b>	UL, LLC
<b>UATS</b>	Universal Automatic Transfer Switch
<b>VRLA</b>	Valve regulated lead acid

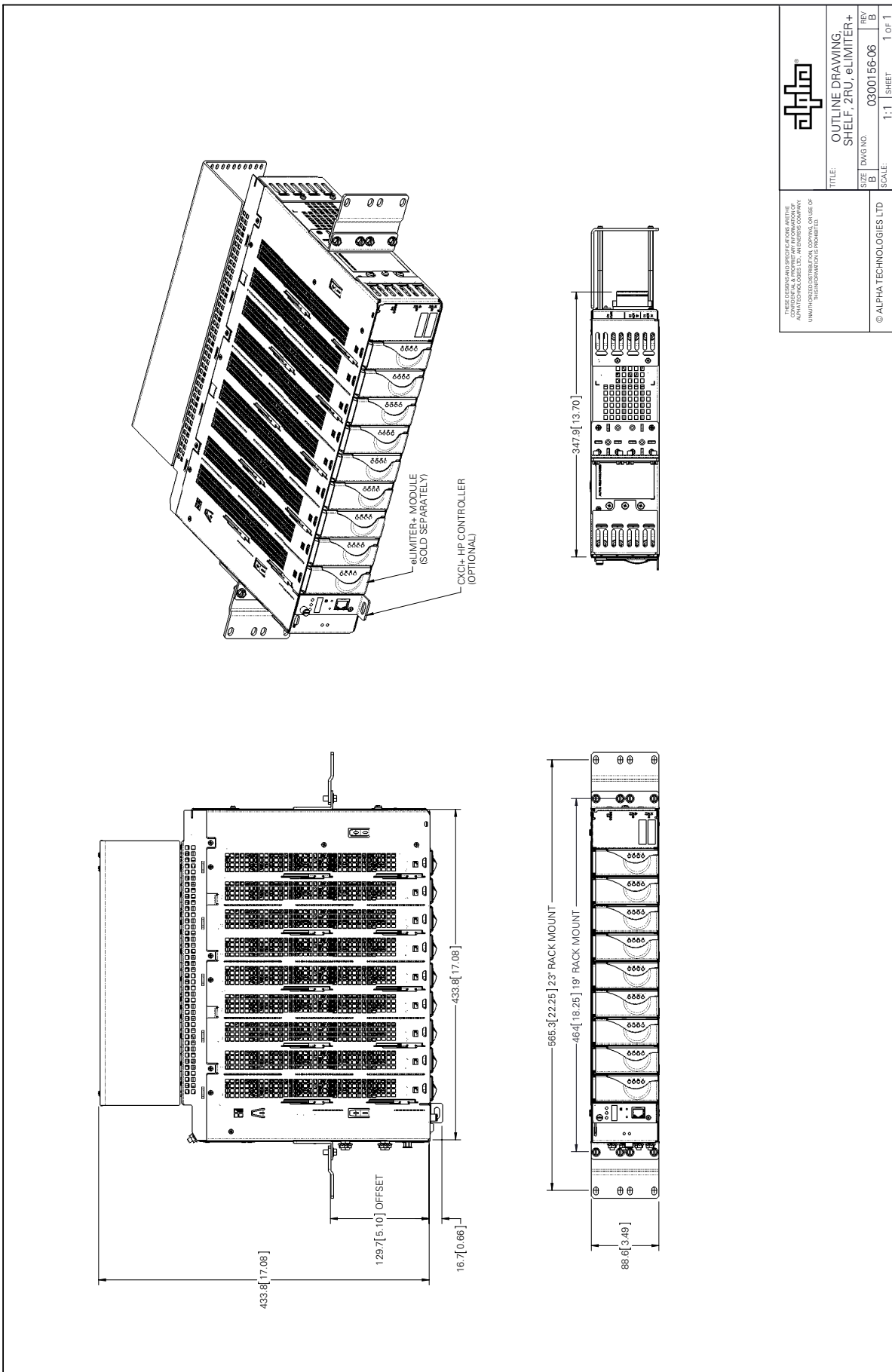

THESE INFORMATION ARE SUBJECT TO OUR PATENT AND PROPRIETARY RIGHTS. ANY REPRODUCTION OR DISTRIBUTION OF THIS DOCUMENT WITHOUT OUR WRITTEN PERMISSION IS PROHIBITED.

	
<b>TITLE:</b> OUTLINE DRAWING: SHELF, 2RU, eLIMITER+	
<b>SIZE:</b> B	<b>DWG NO:</b> 0300156-06
<b>SCALE:</b> 1:1	<b>REV:</b> B
© ALPHA TECHNOLOGIES LTD	<b>SHEET:</b> 1 OF 1

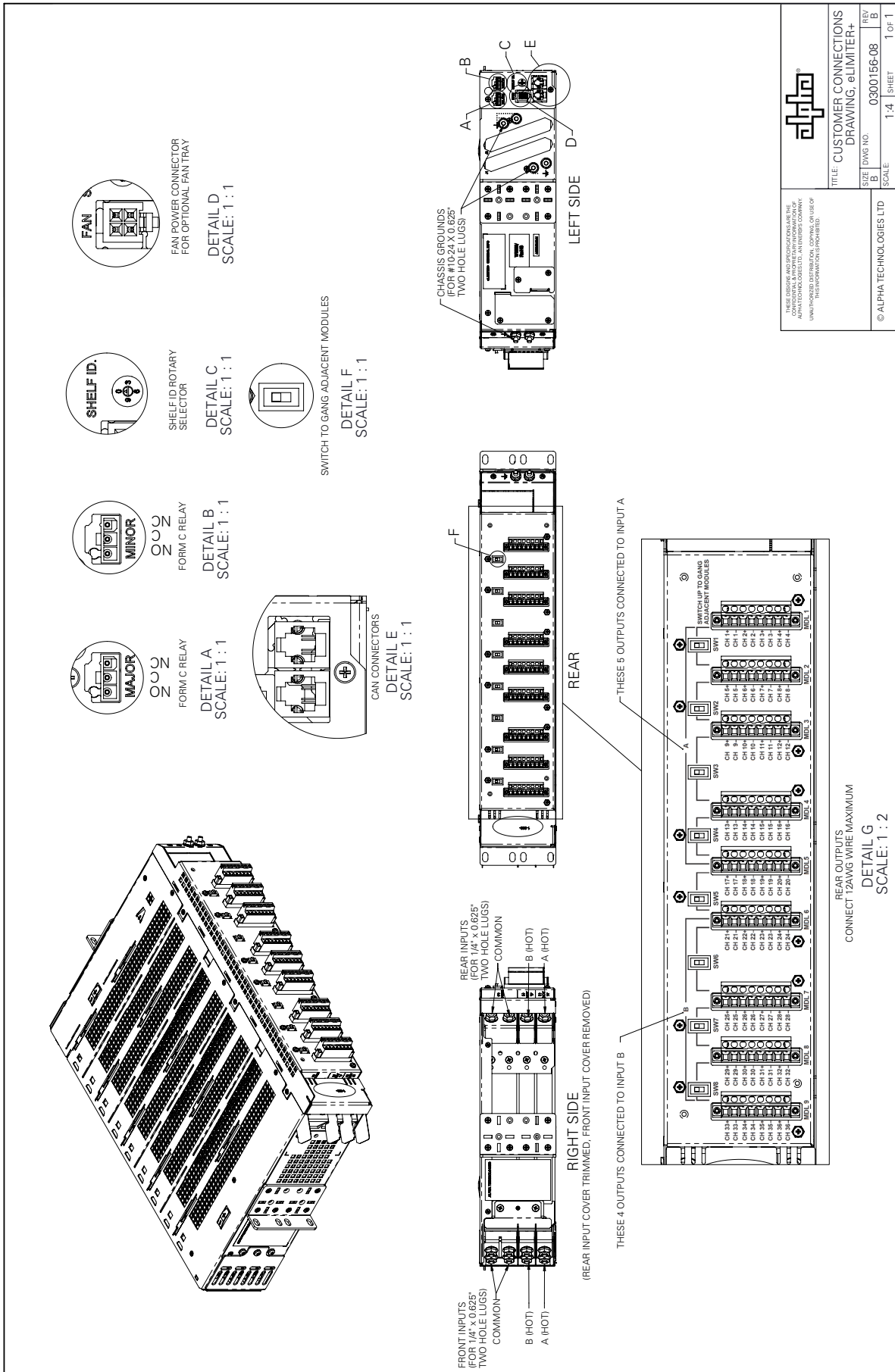



Alpha Technologies Ltd. | 7700 Riverfront Gate, Burnaby, BC V5J 5M4 Canada  
Toll Free North America: +1 800 667 8743 | Outside North America +1 604 436 5547 | Technical Support +1 888 462 7487  
For more information visit our website at: [www.alpha.com](http://www.alpha.com) or [www.alpha.ca](http://www.alpha.ca)  
© 2022 EnerSys. All rights reserved. Trademarks and logos are the property of EnerSys and its affiliates unless otherwise noted.  
Subject to revisions without prior notice. E. & O.E.

0120028-J0 REV G (05/2022)