

EvoRail™ 3PzV210



*VRLA GEL Battery Technology
for Rolling Stock Applications*



*High cycle
performance*

*Very good deep
discharge recovery*

Maintenance free

V-0 flame retardant



Keeping you on track

Hawker® EvoRail™ 3PzV210

Technical specifications

Part number: 1882503V0CP

Electrical Data

Nominal voltage	2 V
Number of cells	1 (VRLA, tubular GEL Technology)
Rated capacity C ₁₀ to 1.80 Vpc at 20 °C	206 Ah
Rated capacity C ₅ to 1.70 Vpc at 30 °C	210 Ah
Current/Power for 0.25 h back-up time 1.60 Vpc 20 °C	297.2 A / 487 W
Current/Power for 0.5 h back-up time 1.60 Vpc 20 °C	211.5 A / 359 W
Current/Power for 1.0 h back-up time 1.60 Vpc 20 °C	135.1 A / 237 W
Current/Power for 3.0 h back-up time 1.70 Vpc 20 °C	57.6 A / 107 W
Current/Power for 5.0 h back-up time 1.75 Vpc 20 °C	37.5 A / 71 W
Current/Power for 8.0 h back-up time 1.75 Vpc 20 °C	25.8 A / 49 W
Current/Power for 10.0 h back-up time 1.80 Vpc 20 °C	20.6 A / 40 W
Current/Power for 24.0 h back-up time 1.80 Vpc 20 °C	10.1 A / 19 W
Conversion to capacity at 25 °C	102% of Current/Power at 20°C
Internal resistance to IEC/EN 60896-21	0.81 mΩ
Short circuit current to IEC/EN 60896-21	2.51kA
Self discharge at 20 °C to IEC/EN 60896-21	max. 3% / Month
Heat loss during float service at 20°C	≈ 0.29 W

Mechanical Data

Weight	14.9 kg ±2%
Height of cell / over terminal cover	405 mm / 435 mm
Width	198 mm
Depth	65 mm
Number of terminals	1 + / 1 -
Dimension of terminal screw hole	M10 x 22 deep, female thread
Torque terminal screw	25 Nm ±2
Terminal insulation class according to IEC/EN 60529	IP 20
Diameter of diagnostic hole for voltage probe	2 mm
Maximum cable cross-section	95 mm ²
Connector and terminal connection	use flexible EVO or PerfectPlus - connectors
Connector (copper, tin-coated and insulated)	For Rolling Stock flexible connectors are recommended
Shock + Vibration rating (according)	Category 1, Class B (IEC 61373:2011)

Environmental Data

Installation	vertically
Cell assembly distance	not required; for higher loads 5-10 mm recommended for cooling
Material of case/cover; Flame retardancy rating (according to)	PP - FR or PP (on request) V-0 (UL94); I2 / F1 (NF F 16-101) or HB (UL94)
Flame barriers at vents	Yes
Rail service life expected at 15 °C	6 years (max. 30% DOD / day)
Cycle Endurance (DB Test : 30% DOD/8h)	> 80% C _{nom} after 1'300 cycles
Design life (Eurobat classification)	12+ Long Life
Shipping name	Batteries, wet, non spillable

Hawker® EvoRail™ 3PzV210

Operating specifications

Figure 1



Figure 2

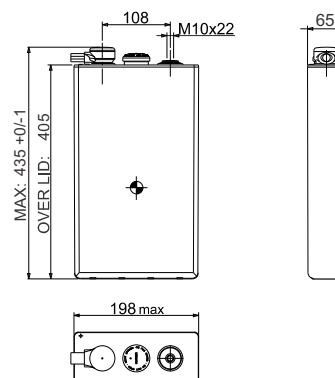
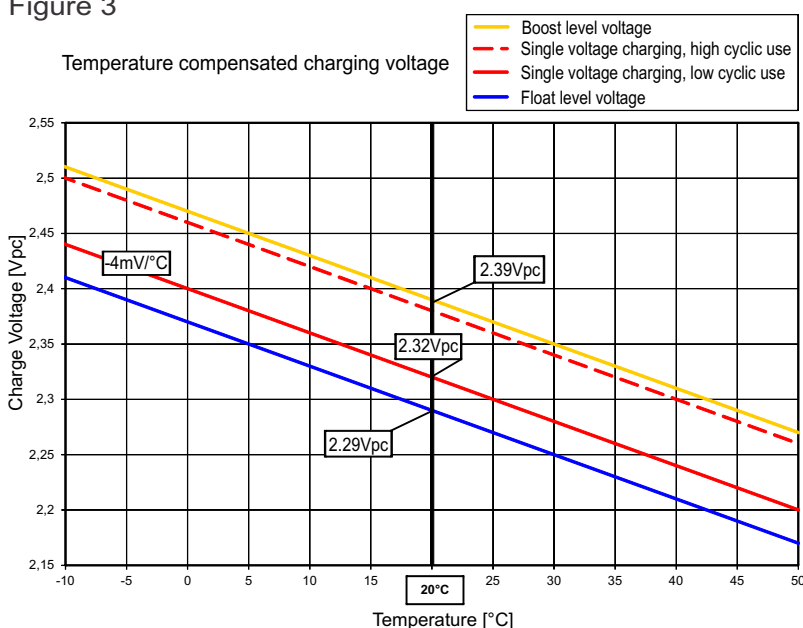

Figure 3



Temperature in °C	Percent of the rated capacity (C ₅)
40	107.0
35	105.8
30	104.0
25	102.0
20	100.0
15	97.8
10	94.5
5	91.0
0	86.0
-5	80.0
-10	72.5
-15	64.0
-20	47.0
-25	31.0
-30	14.0

*Estimated Values
Should be verified with actual load profile*

Battery installation and operation

Recommended charging for rolling stock applications (standby parallel operation)	IU0U - charging : 2 level charging (acc. DIN 41773) with current limitation and temperature compensation
Boost level voltage setting at 20°C	2.39 Vpc (Volt per cell)
Lower level or constant voltage setting at 20°C	2.32 ... 2.38 Vpc (low ... high cyclic use)
Charge current for IU or IU0U-charging (DIN 41773)	38 ... 57 A (minimum for cyclic use: 48 A)
Voltage compensation in function of temperature	- 4 mV/K per cell
Float level voltage setting at 20°C (± 1%)	2.29 Vpc (valid for long term trickle charging at workshop and storage)
Air exchange	As a VRLA battery according to EN 50272-2 : 2001 $Q = 0.05 * N_{cells} * I_{gas} * C_{AhC10} * 10^{-3} [m^3/h]$ $I_{gas} = 1$ (at 2.29 Vpc) ; $I_{gas} = 8$ (at 2.39 Vpc)
Preferred operating temperature range	Between 15°C - 25°C
Maximum long term operating temperature	+40°C with ventilation assured (reduced service life)
Maximum short term operating temperature (< 3h)	+50°C with ventilation assured (reduced service life)
Minimum operating and storage temperature	- 40°C (in charged condition)

Hawker® EvoRail™ 3PzV210

Discharge data per cell

Constant current performance [Ampere] to the defined end of discharge voltage

Voltage [Vpc]	Temp	Discharge time [h:min]																		
		0:01	0:05	0:10	0:15	0:20	0:25	0:30	0:40	0:50	1:00	1:30	2:00	3:00	4:00	5:00	8:00	10:00	12:00	24:00
1.90	20°C	151.0	142.0	131.2	120.9	112.4	105.4	98.8	88.8	80.5	73.9	59.6	50.2	38.8	31.8	27.1	19.1	16.0	13.9	8.4
	25°C	151.4	142.6	132.7	123.0	114.6	107.7	101.3	91.2	83.0	76.2	61.6	52.0	40.2	32.9	28.0	19.7	16.6	14.3	8.6
1.85	20°C	200.6	190.9	173.2	159.0	147.2	136.6	127.7	113.3	101.9	92.9	73.6	61.4	46.8	38.1	32.2	22.5	18.9	16.3	9.4
	25°C	201.1	192.2	175.8	162.0	150.4	140.2	131.4	117.0	105.5	96.3	76.4	63.9	48.6	39.6	33.5	23.3	19.5	16.9	9.7
1.80	20°C	252.4	236.7	212.4	193.5	177.5	164.1	152.8	133.8	119.2	107.9	84.3	69.7	52.3	42.2	35.6	24.7	20.6	17.8	10.1
	25°C	252.4	239.0	216.0	197.8	182.3	169.0	157.6	138.9	124.0	112.4	88.0	72.7	54.5	44.0	37.1	25.6	21.4	18.4	10.4
1.75	20°C	305.8	280.7	248.8	224.3	204.2	187.6	173.1	150.2	132.5	118.9	91.4	74.9	55.6	44.7	37.5	25.8	21.6	18.6	10.3
	25°C	305.8	284.1	253.7	229.9	210.3	193.8	179.5	156.4	138.5	124.3	95.7	78.4	58.1	46.6	39.1	26.8	22.4	19.2	10.7
1.70	20°C	359.2	322.4	282.5	252.1	227.2	206.6	189.3	162.2	142.0	126.4	95.9	78.0	57.6	46.1	38.5	26.2	21.8	18.8	10.3
	25°C	359.2	326.7	288.9	259.4	235.1	214.5	197.2	169.7	148.9	132.7	100.8	81.8	60.3	48.1	40.2	27.3	22.6	19.4	10.7
1.65	20°C	412.6	362.6	313.8	276.4	246.4	222.0	202.0	171.0	148.5	131.5	98.9	79.9	58.1	46.2	38.5	26.2	21.8	18.8	10.3
	25°C	412.6	368.1	321.6	285.5	256.0	231.6	211.3	179.6	156.3	138.4	104.1	84.0	60.9	48.3	40.2	27.3	22.6	19.4	10.7
1.60	20°C	465.9	401.0	342.1	297.2	262.3	234.2	211.5	177.4	153.2	135.1	99.6	79.9	58.1	46.2	38.5	26.2	21.8	18.8	10.3
	25°C	465.9	408.1	351.8	308.2	273.6	245.4	222.2	186.9	161.6	142.5	105.1	84.0	60.9	48.3	40.2	27.3	22.6	19.4	10.7

Constant power performance [Watt per cell] to the defined end of discharge voltage

Voltage [Vpc]	Temp	Discharge time [h:min]																		
		0:01	0:05	0:10	0:15	0:20	0:25	0:30	0:40	0:50	1:00	1:30	2:00	3:00	4:00	5:00	8:00	10:00	12:00	24:00
1.90	20°C	286.8	270.3	249.3	230.4	214.3	200.9	188.8	169.7	154.6	142.2	115.0	97.5	75.4	62.3	53.1	37.5	31.6	27.3	16.5
	25°C	287.3	270.7	252.3	234.2	218.3	205.3	193.5	174.1	159.1	146.7	118.7	100.9	78.1	64.5	55.0	38.7	32.6	28.2	16.9
1.85	20°C	370.6	353.1	320.7	295.0	273.8	254.7	238.5	212.2	191.5	174.6	139.7	116.8	89.6	73.2	62.4	43.5	36.7	31.8	18.3
	25°C	371.6	355.9	325.3	300.8	280.1	261.3	245.2	219.1	198.0	180.9	145.1	121.5	93.2	76.0	64.8	45.1	37.9	32.8	18.8
1.80	20°C	454.3	426.2	383.3	350.0	322.3	298.7	278.7	245.8	219.9	199.2	156.9	130.6	98.9	80.1	68.0	47.3	39.6	34.3	19.4
	25°C	454.3	430.4	389.7	357.5	330.5	307.1	287.2	254.5	228.4	207.5	163.6	136.3	103.1	83.5	70.7	49.1	41.0	35.5	20.0
1.75	20°C	530.3	489.6	437.6	395.6	361.9	333.4	309.3	270.1	240.3	216.6	168.1	138.8	104.0	84.0	70.8	49.2	41.0	35.5	19.9
	25°C	530.3	494.8	445.9	405.2	372.2	344.5	320.2	280.9	250.4	226.1	175.9	145.1	108.5	87.7	73.7	51.1	42.5	36.7	20.5
1.70	20°C	605.8	545.7	482.1	433.7	393.6	360.0	331.8	287.2	253.4	227.3	174.5	143.0	106.6	86.0	72.2	49.8	41.4	35.7	19.9
	25°C	605.9	552.6	491.8	445.4	406.1	373.0	344.8	299.7	265.0	238.0	183.0	149.8	111.5	89.9	75.4	51.9	43.0	37.0	20.6
1.65	20°C	680.1	597.5	520.6	463.8	417.7	379.9	348.1	298.5	261.7	233.7	178.1	145.4	107.4	86.3	72.2	49.8	41.4	35.7	19.9
	25°C	680.1	606.6	532.6	477.7	432.4	394.9	363.0	312.4	274.6	245.2	187.2	152.7	112.7	90.2	75.5	51.9	43.0	37.0	20.6
1.60	20°C	741.9	644.8	553.8	487.4	435.8	393.6	359.2	305.6	267.0	237.5	179.3	145.5	107.4	86.3	72.2	49.8	41.4	35.7	19.9
	25°C	741.9	655.4	568.4	503.7	452.8	410.8	375.7	320.9	280.6	249.8	189.0	153.0	112.7	90.2	75.5	51.9	43.0	37.0	20.6

Constant discharge values without voltage loss in connectors and cables!
Our technical support offers to calculate the discharge curve for a specific load profile.



Global & Americas
Headquarters
EnerSys
2366 Bernville Road
Reading,
Pennsylvania 19605
USA
Tel. + 1-610-208-1991

EMEA
Headquarters
EH Europe GmbH
Löwenstrasse 32
8001 Zürich
Switzerland
Tel: +41 (0)44 215 74 10
Fax: +41 (0)44 215 74 11

EH Europe GmbH
PDAC EMEA
Hagnastrasse 27
4132 Muttenz
Switzerland
Tel: +41 61 706 36 36
Fax: +41 61 706 36 37