

EvoRail™ 2PzV140



*VRLA GEL Battery Technology
for Rolling Stock Applications*



*High cycle
performance*

*Very good deep
discharge recovery*

Maintenance free

V-0 flame retardant



Keeping you on track

Hawker® EvoRail™ 2PzV140

Technical specifications

Part number: 1882502V0CP

Electrical Data

Nominal voltage	2 V
Number of cells	1 (VRLA, tubular GEL Technology)
Rated capacity C ₁₀ to 1.80 Vpc at 20 °C	138 Ah
Rated capacity C ₅ to 1.70 Vpc at 30 °C	140 Ah
Current/Power for 0.25 h back-up time 1.60 Vpc 20 °C	198.1 A / 325 W
Current/Power for 0.5 h back-up time 1.60 Vpc 20 °C	141.0 A / 239 W
Current/Power for 1.0 h back-up time 1.60 Vpc 20 °C	90.1 A / 158 W
Current/Power for 3.0 h back-up time 1.70 Vpc 20 °C	38.4 A / 71 W
Current/Power for 5.0 h back-up time 1.75 Vpc 20 °C	25.0 A / 47 W
Current/Power for 8.0 h back-up time 1.75 Vpc 20 °C	17.2 A / 33 W
Current/Power for 10.0 h back-up time 1.80 Vpc 20 °C	13.8 A / 26 W
Current/Power for 24.0 h back-up time 1.80 Vpc 20 °C	6.7 A / 13 W
Conversion to capacity at 25 °C	102% of Current/Power at 20°C
Internal resistance to IEC/EN 60896-21	1.21 mΩ
Short circuit current to IEC/EN 60896-21	1.68 kA
Self discharge at 20 °C to IEC/EN 60896-21	max. 3% / Month
Heat loss during float service at 20°C	≈ 0.19 W

Mechanical Data

Weight	10.5 kg ±2%
Height of cell / over terminal cover	405 mm / 435 mm
Width	198 mm
Depth	47 mm
Number of terminals	1 + / 1 -
Dimension of terminal screw hole	M10 x 22 deep, female thread
Torque terminal screw	25 Nm ±2
Terminal insulation class according to IEC/EN 60529	IP 20
Diameter of diagnostic hole for voltage probe	2 mm
Maximum cable cross-section	95 mm ²
Connector and terminal connection	use flexible EVO or PerfectPlus - connectors
Connector (copper, tin-coated and insulated)	For Rolling Stock flexible connectors are recommended
Shock + Vibration rating (according)	Category 1, Class B (IEC 61373:2011)

Environmental Data

Installation	vertically
Cell assembly distance	not required; for higher loads 5-10 mm recommended for cooling
Material of case/cover; Flame retardancy rating (according to)	PP - FR or PP (on request) V-0 (UL94); I2 / F1 (NF F 16-101) or HB (UL94)
Flame barriers at vents	Yes
Rail service life expected at 15 °C	6 years (max. 30% DOD / day)
Cycle Endurance (DB Test : 30% DOD/8h)	> 80% C _{nom} after 1'300 cycles
Design life (Eurobat classification)	12+ Long Life
Shipping name	Batteries, wet, non spillable

Hawker® EvoRail™ 2PzV140

Operating specifications

Figure 1



Figure 2

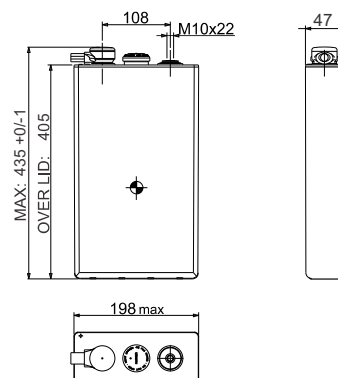
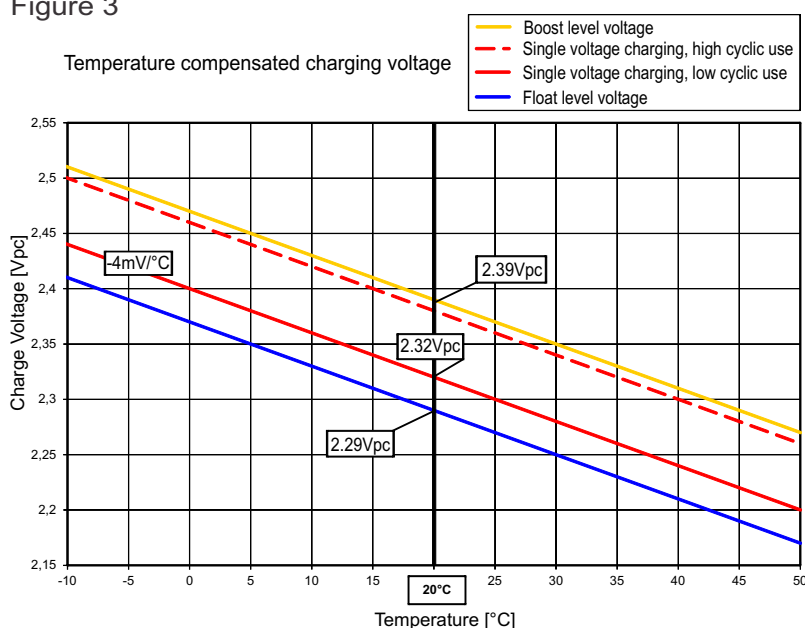

Figure 3



Temperature in °C	Percent of the rated capacity (C ₅)
40	107.0
35	105.8
30	104.0
25	102.0
20	100.0
15	97.8
10	94.5
5	91.0
0	86.0
-5	80.0
-10	72.5
-15	64.0
-20	47.0
-25	31.0
-30	14.0

*Estimated Values
Should be verified with actual load profile*

Battery installation and operation

Recommended charging for rolling stock applications (standby parallel operation)	IU0U - charging : 2 level charging (acc. DIN 41773) with current limitation and temperature compensation
Boost level voltage setting at 20°C	2.39 Vpc (Volt per cell)
Lower level or constant voltage setting at 20°C	2.32 ... 2.38 Vpc (low ... high cyclic use)
Charge current for IU or IU0U-charging (DIN 41773)	25 ... 38 A (minimum for cyclic use: 32 A)
Voltage compensation in function of temperature	- 4 mV/K per cell
Float level voltage setting at 20°C (± 1%)	2.29 Vpc (valid for long term trickle charging at workshop and storage)
Air exchange	As a VRLA battery according to EN 50272-2 : 2001 $Q = 0.05 * N_{cells} * I_{gas} * C_{AhC10} * 10^{-3} [m^3/h]$ $I_{gas} = 1$ (at 2.29 Vpc) ; $I_{gas} = 8$ (at 2.39 Vpc)
Preferred operating temperature range	Between 15°C - 25°C
Maximum long term operating temperature	+40°C with ventilation assured (reduced service life)
Maximum short term operating temperature (< 3h)	+50°C with ventilation assured (reduced service life)
Minimum operating and storage temperature	- 40°C (in charged condition)

Hawker® EvoRail™ 2PzV140

Discharge data per cell

Constant current performance [Ampere] to the defined end of discharge voltage

Voltage [Vpc]	Temp	Discharge time [h:min]																			
		0:01	0:05	0:10	0:15	0:20	0:25	0:30	0:40	0:50	1:00	1:30	2:00	3:00	4:00	5:00	8:00	10:00	12:00	24:00	
1.90	20°C	100.6	94.7	87.5	80.6	75.0	70.3	65.9	59.2	53.7	49.3	39.7	33.5	25.8	21.2	18.0	12.7	10.7	9.3	5.6	
	25°C	100.9	95.1	88.5	82.0	76.4	71.8	67.6	60.8	55.3	50.8	41.1	34.7	26.8	21.9	18.7	13.1	11.0	9.5	5.8	
1.85	20°C	133.7	127.3	115.5	106.0	98.1	91.1	85.2	75.5	67.9	61.9	49.0	41.0	31.2	25.4	21.5	15.0	12.6	10.9	6.3	
	25°C	134.1	128.2	117.2	108.0	100.3	93.5	87.6	78.0	70.3	64.2	51.0	42.6	32.4	26.4	22.3	15.5	13.0	11.3	6.5	
1.80	20°C	168.3	157.8	141.6	129.0	118.3	109.4	101.9	89.2	79.5	71.9	56.2	46.4	34.8	28.2	23.7	16.4	13.8	11.9	6.7	
	25°C	168.3	159.3	144.0	131.8	121.5	112.7	105.1	92.6	82.7	74.9	58.7	48.5	36.3	29.3	24.7	17.1	14.3	12.3	6.9	
1.75	20°C	203.9	187.2	165.9	149.5	136.2	125.1	115.4	100.1	88.4	79.2	60.9	49.9	37.1	29.8	25.0	17.2	14.4	12.4	6.9	
	25°C	203.9	189.4	169.1	153.2	140.2	129.2	119.7	104.3	92.3	82.9	63.8	52.2	38.8	31.1	26.1	17.9	14.9	12.8	7.1	
1.70	20°C	239.5	214.9	188.3	168.1	151.5	137.7	126.2	108.2	94.7	84.3	64.0	52.0	38.4	30.7	25.7	17.5	14.5	12.5	6.9	
	25°C	239.5	217.8	192.6	172.9	156.7	143.0	131.5	113.1	99.3	88.5	67.2	54.5	40.2	32.1	26.8	18.2	15.1	13.0	7.1	
1.65	20°C	275.0	241.7	209.2	184.3	164.3	148.0	134.6	114.0	99.0	87.7	65.9	53.2	38.7	30.8	25.7	17.5	14.5	12.5	6.9	
	25°C	275.0	245.4	214.4	190.4	170.6	154.4	140.9	119.8	104.2	92.3	69.4	56.0	40.6	32.2	26.8	18.2	15.1	13.0	7.1	
1.60	20°C	310.6	267.3	228.0	198.1	174.9	156.1	141.0	118.3	102.2	90.1	66.4	53.2	38.7	30.8	25.7	17.5	14.5	12.5	6.9	
	25°C	310.6	272.1	234.5	205.5	182.4	163.6	148.1	124.6	107.7	95.0	70.1	56.0	40.6	32.2	26.8	18.2	15.1	13.0	7.1	

Constant power performance [Watt per cell] to the defined end of discharge voltage

Voltage [Vpc]	Temp	Discharge time [h:min]																			
		0:01	0:05	0:10	0:15	0:20	0:25	0:30	0:40	0:50	1:00	1:30	2:00	3:00	4:00	5:00	8:00	10:00	12:00	24:00	
1.90	20°C	191.2	180.2	166.2	153.6	142.9	133.9	125.9	113.1	103.0	94.8	76.6	65.0	50.3	41.5	35.4	25.0	21.0	18.2	11.0	
	25°C	191.5	180.5	168.2	156.1	145.6	136.9	129.0	116.1	106.1	97.8	79.1	67.3	52.0	43.0	36.7	25.8	21.7	18.8	11.3	
1.85	20°C	247.1	235.4	213.8	196.7	182.6	169.8	159.0	141.4	127.7	116.4	93.1	77.9	59.7	48.8	41.6	29.0	24.5	21.2	12.2	
	25°C	247.8	237.3	216.9	200.6	186.7	174.2	163.5	146.1	132.0	120.6	96.7	81.0	62.1	50.6	43.2	30.0	25.3	21.9	12.6	
1.80	20°C	302.8	284.1	255.5	233.3	214.8	199.1	185.8	163.9	146.6	132.8	104.6	87.1	66.0	53.4	45.3	31.5	26.4	22.9	13.0	
	25°C	302.8	286.9	259.8	238.3	220.3	204.8	191.5	169.7	152.3	138.3	109.1	90.8	68.7	55.7	47.1	32.7	27.3	23.6	13.3	
1.75	20°C	353.5	326.4	291.7	263.8	241.3	222.3	206.2	180.1	160.2	144.4	112.1	92.5	69.4	56.0	47.2	32.8	27.3	23.6	13.3	
	25°C	353.5	329.9	297.3	270.2	248.1	229.6	213.5	187.3	167.0	150.8	117.2	96.7	72.4	58.5	49.1	34.1	28.3	24.5	13.7	
1.70	20°C	403.9	363.8	321.4	289.1	262.4	240.0	221.2	191.5	168.9	151.5	116.3	95.4	71.1	57.4	48.1	33.2	27.6	23.8	13.3	
	25°C	403.9	368.4	327.9	296.9	270.7	248.7	229.9	199.8	176.7	158.6	122.0	99.8	74.3	59.9	50.3	34.6	28.7	24.7	13.7	
1.65	20°C	453.4	398.3	347.1	309.2	278.5	253.2	232.0	199.0	174.5	155.8	118.8	96.9	71.6	57.5	48.1	33.2	27.6	23.8	13.3	
	25°C	453.4	404.4	355.1	318.5	288.3	263.3	242.0	208.2	183.1	163.5	124.8	101.8	75.1	60.2	50.3	34.6	28.7	24.7	13.7	
1.60	20°C	494.6	429.9	369.2	324.9	290.6	262.4	239.5	203.7	178.0	158.3	119.5	97.0	71.6	57.5	48.1	33.2	27.6	23.8	13.3	
	25°C	494.6	436.9	378.9	335.8	301.9	273.8	250.5	214.0	187.1	166.6	126.0	102.0	75.1	60.2	50.3	34.6	28.7	24.7	13.7	

Constant discharge values without voltage loss in connectors and cables!
Our technical support offers to calculate the discharge curve for a specific load profile.



Global & Americas
Headquarters
EnerSys
2366 Bernville Road
Reading,
Pennsylvania 19605
USA
Tel. + 1-610-208-1991

EMEA
Headquarters
EH Europe GmbH
Löwenstrasse 32
8001 Zürich
Switzerland
Tel: +41 (0)44 215 74 10
Fax: +41 (0)44 215 74 11

EH Europe GmbH
PDAC EMEA
Hagnastrasse 27
4132 Muttenz
Switzerland
Tel: +41 61 706 36 36
Fax: +41 61 706 36 37