

# GAZ<sup>®</sup>

SOL...G

Battery Installation,  
Operation and  
Maintenance Instructions

**EnerSys**<sup>®</sup>

*Power/Full Solutions*

Visit us at [www.enersys.com](http://www.enersys.com)

**Warning!**

The gases emitted during charging are explosive. The electrolyte (potassium hydroxide, KOH) is highly corrosive. Exposed metal parts of the battery always conduct a voltage and are electrically active parts. Precautions in accordance with IEC 62485-2:2010 must be observed.



Observe the instructions for use and place them visibly close to the battery! Work only on batteries after receiving instruction from qualified personnel!



Warning: Risk of fire, explosion, or burns! Avoid any short circuit! Metallic parts of the battery are always under voltage on the battery, do not place tools or items on top of the battery!



When working on batteries wear safety glasses and protective clothing. All metallic personal objects, such as rings, watches, bracelets etc. shall be removed before starting work on the battery! Only use insulated tools! Comply strictly with the accident prevention regulations and your national Health and Safety standards as well as IEC 62485-1:2010



Electrolyte is highly corrosive!



Cells are heavy! Make sure they are safely installed! Only use suitable transport equipment!



Electrolyte is harmful to skin and eyes. Therefore, after an accidental contact with the electrolyte flood the eyes immediately with large quantities of clean water for an extended period of time of at least 15 minutes. In all cases, consult a doctor immediately! Clothing contaminated with electrolyte should be washed in water immediately!



No smoking! Do not allow naked flames, embers or sparks near the battery due to the risk of explosion or fire!

The Installation, Operation and Maintenance Instructions must be strictly observed.

Non-compliance with the Installation, Operation and Maintenance Instructions, use of nongenuine spares and the usage of other than by EnerSys/GAZ specified parts, use of additives to the electrolyte and unauthorised tampering will invalidate any entitlement to warranty.

Used batteries with this symbol are recyclable products and have to be put into a recycling system. Used batteries must be disposed of as special waste in accordance with all standards.



**WARNING!**  
Never use sulphuric acid or acidic water.  
Acid will damage the battery!

**1. Receiving the battery**

Cells must not be stored in their packaging, therefore, unpack the battery immediately upon receipt. Do not tilt the package or turn it upside down. The battery cells are equipped with a blue plastic transport plug. SOL...G batteries will be delivered **filled and charged**. The battery is ready for installation. Replace the transport plug with the yellow vent cap included in the accessories just before use (see section 7).

**The battery must not be charged with the transport plug installed as this can damage the battery.**

**2. Storage**

The rooms provided for storing the batteries must be clean, dry, cool (+10°C to +30°C) and well ventilated. Cells must not be stored in the transport packaging and must not be exposed to direct sunlight or UV-radiation.

**If the cells are delivered in plywood boxes, open the boxes before storage and remove the packing material on the top of the cells. If the cells are delivered on pallets, remove the packing material on the top of the cells.**

Filled SOL...G cells can be stored up to 12months from the day of delivery.

Storage of filled cells at a temperature above +30°C will result in a loss of capacity of approximately 5% per 10 degrees per year. It is very important that the cells are sealed with the plastic transport plugs tightly in place. This is to be checked after receiving the goods. In case of electrolyte loss during transport, refill the cell up to the "MAX" mark with genuine electrolyte before storage.

**3. Installation**

The installation should be carried out in accordance with the requirements of IEC 62485-2:2010, Part 2 "Safety Requirements for secondary batteries and battery installations – Part 2: Stationary batteries". For non-stationary installations, specific standards may also apply.

**3.1 Location**

Install the battery in a dry and clean room. Avoid exposure to direct sunlight and heat. The battery will give the optimal performance and maximum service life if the ambient temperature range is between +10°C and +30°C.

**3.2 Ventilation**

During the last phase of charging, battery gases are released (a mixture of oxygen and hydrogen). Ventilation is necessary, even if the generation of gas is very low during float charging.

**Compliance with local regulations as to ventilation may be necessary for certain applications. If there are no special regulations, standard IEC 62485-2:2010, Part 2 must be met.**

**3.3 Setting up**

Always follow the assembly drawings, circuit diagrams and other separate instructions. In the case of parallel string connection only use battery cells of the same capacity, design and age up to a maximum of two parallel strings. For parallel connection of more than two strings, please contact the manufacturer for technical approval. Use nickel-plated cable lugs for cable connections.

The transport plugs have to be replaced by the yellow vent caps included in the accessories.

Tighten the terminal screws with corresponding tightening torque as per table 1.

It is recommended to use a calibrated torque wrench.

Table 1: Torque loadings for terminal screws:

Terminal	Torque
M8	20-25 Nm
M10	25-30 Nm

Connectors and terminals should be protected by a thin layer coating of anti corrosion grease.

### 3.4 Electrolyte

The electrolyte for SOL...G NiCd batteries consists of a diluted potassium hydroxide (KOH) solution (specific gravity 1.22 kg/litre +/-0.01 kg/litre) with a lithium hydroxide component, in accordance with IEC 60993:1989. The potassium hydroxide solution is prepared in accordance with factory regulations. The specific gravity of the electrolyte does not indicate the state of charge of the battery. The specific gravity changes very little during charging and discharging, and has limited relationship to the temperature.

When checking the electrolyte levels, a variation in level between cells is not unusual and is due to the different quantity of gas held in the separators of each cell. Before the battery is put into service for the first time, check that the electrolyte level is not lower than 10mm below the "MAX" mark. There is usually no need to adjust it.

**If the electrolyte level is lower than the "MIN" level during service, the battery should not be disconnected from the charger for a time longer than 12 hours.**

**If visual inspection is not possible, due to restricted view, use an electrolyte level testing tube to check the electrolyte level. For further instructions, please contact your GAZ/EnerSys representative.**

### 3.5 Commissioning

#### 3.5.1 Site Test

**If a site test is requested, it must be carried out in accordance with IEC 61427-1:2013 / IEC 62259:2003.**

**Charge and discharge currents for tests shall be based on the value of the rated capacity ( $C_5$  Ah). These currents are expressed as:**

$$I_t A = \frac{C_n \text{ Ah}}{1h}$$

Example: Cell type:	SOL 1110 G
Rated capacity:	$C_{120} = 1110 \text{ Ah}$
Rated capacity:	$C_5 = 1056 \text{ Ah}$
Constant charging current (14-16 h):	$0.1 I_t A = 105.6 \text{ A}$
Battery discharge current (5 hours):	$0.2 I_t A = 1056 \text{ A} \times 0.1 = 211.2 \text{ A}$

#### 3.5.2 SOL...G cells stored up to 6 months

A commissioning charge is normally not required and the cells are ready for service. If full performance is necessary immediately, it is recommended to charge the cell according to point 3.5.3.

#### 3.5.3 Commissioning of SOL..G cells stored more than 6 months and up to 12 months

##### 3.5.3.1 Commissioning procedures for ambient temperatures of +10°C up to +30°C

*Mode of charging:* **Constant voltage**  
Charging voltage 1.65 V/cel  
Current limitation 0.1  $I_t$  A

Duration: 30 hour

*Mode of charging:* **Constant current**  
Current limitation 0.1  $I_t$  A

Duration: 15 hours

During the charge the temperature should be checked (see point 3.5.3.3).

##### 3.5.3.2 Commissioning procedures for ambient temperatures of +30°C up to +40°C

Constant current charge mode is the only approved method for charging under such conditions. The battery must be connected directly with the PV-Installation (the consumer load is disconnected). The battery capacity shall be measured for the whole period of recharge during sunshine hours. 1.6 times the 5 hour rate shall be used to recharge the battery during the commissioning procedure.

*Mode of charging* **Constant current**

Minimum charging current: 0.05  $I_t$  A

Maximum charging current: 0.1  $I_t$  A

During the charge the temperature should be checked (see point 3.5.3.3).

##### 3.5.3.3 Electrolyte temperature

During the whole commissioning process, check the electrolyte temperature. The temperature of the electrolyte should never exceed +45°C, as higher temperatures have a detrimental effect on the performance and lifetime of the cells. On exceeding +45°C the charging should be temporarily interrupted until the electrolyte temperature drops to +40°C.

## 4. Charging in operation

The supply of consumers and the charge of SOL...G batteries in PV applications is challenging because of the sunshine hours and the limited power supplies in such systems. It is necessary to use a charge controller to maintain the battery in proper conditions.

There are two methods of charging established in the market for PV-offgrid charge controllers:

- Constant voltage charge controller
- Pulse charge controller

The following table represents the system settings for a typical PV-offgrid application with 5 days or more autonomy time. Note, these limits are provided only as a guideline. It may be necessary to modify and to adjust the settings on the current operating conditions.

Charge controller Constant voltage principle	Charge controller Pulse Charge principle
<b>Single step charge:</b> Charging voltage: 1.50 V/cell  Current limitation: 0.1 $I_t$ A	Threshold values: Switching threshold ON: 1.45 V/cell Switching threshold: OFF: 1.55 up to 1.65 V/cell Current limitation: 0.1 $I_t$ A
<b>Two step charge:</b>  Float mode: 1.42-1.50 V/cell Boost mode: 1.55 up to 1.65 V/cell Current limitation: 0.1 $I_t$ A	

For temperatures lower than +10°C, the correction factor for charge voltage is -3 mV/K per cell. It is not necessary to adjust the charge voltage for higher temperatures.

## 5. Periodic maintenance

GAZ® SOL...G provides good reliability with long maintenance intervals in typical PV stand-by applications. In order to sustain a permanent availability of the system, we recommend the following:

### Standard service inspection

In a regular twelve months period, carry out a check-up under normal operating conditions. Depending on site location, water consumption, local regulations, or special application requests, these check-ups can vary in frequency or period.

When performing the standard service inspections please be sure to carry out the following:

- General appearance and cleanliness of all the batteries and the battery room or shelter.

The battery must be kept clean using only water. Do not use a wire brush or solvents/additives of any kind. Ventilation must fulfill the requirements of section 3.2.

- Electrolyte level

Visually check the electrolyte level. Refilling is recommended when the electrolyte level reaches the "MIN" mark. However it must never drop below the "WARNING LEVEL" mark. Adjust the electrolyte level only in fully charged conditions. Only use distilled or deionized water to top-up the cells in accordance with IEC 60993:1989. Because of the specifics of PV-Installation the time interval for topping up should be adjusted depending on the water consumption.

**NOTE: Once the battery has been filled with the correct electrolyte at the factory, there is no need to regularly check the electrolyte density. Interpretation of density measurements is difficult and could lead to misunderstandings.**

- Electrical parameters

Check the voltage measurements of every single cell and the battery charging current.

It is important that the recommended charging voltage remains unchanged. High water consumption of the battery is usually caused by improper voltage settings of the charge controller. If a battery is parallel connected the charging current in the strings should also be checked to ensure equality.

- Electrolyte temperature

Check the electrolyte temperature from one of the cells in the middle of the battery.

### Extended service inspection

Regular check every 24 months

In addition to the standard service inspection the following measures are required:

- Connector torque and corrosion protection

Check that all connectors, nuts and screws are correctly torqued. All metal parts of the battery should be coated with a thin layer of anti-corrosion grease supplied by GAZ. Do not coat any plastic parts of the battery, for example cell cases.

### Measurement readings - battery log book

It is recommended to utilize a battery log book. Within this log book, one should record all significant events such as power cuts, service activities, inspections, discharge tests, equalizing charges, topping up dates. If needed, these battery log books can be obtained from GAZ/EnerSys.

## 6. Additional warning notes

Lead-acid and NiCd batteries shall preferably be accommodated in separate rooms. Where both battery types are located in the same room, the charging gases from the lead-acid batteries must be kept away from the NiCd batteries. Tools for lead-acid batteries must not be used for NiCd batteries.

### Risk of short circuit and fire:

Do not place electrically conductive objects such as tools etc. on top of the battery!

### Risk of injury:

No rings or metal bracelets should be worn during the assembly of the battery.

### Risk of explosion:

Open the doors of the battery cabinet during charging so that the charging gases can escape.

The charging gases from batteries are explosive. Do not allow naked flames, sparks or other sources of ignition in the vicinity of the battery!

### Caution – potassium hydroxide solution is corrosive!

A potassium hydroxide solution is used as electrolyte. It is a highly corrosive liquid which can cause severe damage to health if it comes into contact with eyes or skin (risk of blinding). Even swallowing of small quantities may cause internal injuries.

**When working with the electrolyte and on the cells or batteries, rubber gloves, safety glasses with side guards, and protective clothing must always be worn!**

### Contact with the eyes:

Flood eyes immediately with large quantities of water for 10 to 15 minutes. Consult a doctor immediately.

### Contact with the skin:

Remove contaminated clothing immediately and wash the affected skin areas with large quantities of water. In case of discomfort seek medical advice.

### Swallowing:

Rinse the mouth immediately with large quantities of water and keep drinking large amounts of water. Do not provoke vomiting. Call an emergency doctor immediately.

### In the event of injuries:

Rinse thoroughly for a long time under running water. Consult a doctor immediately.

7. Removal of the Transportation Plugs and Fitting of Vent Caps

SOL 140-485 G

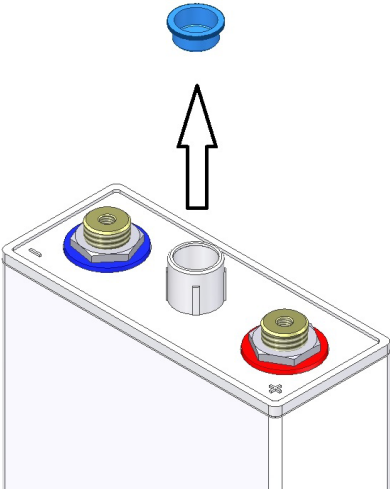

Step 1

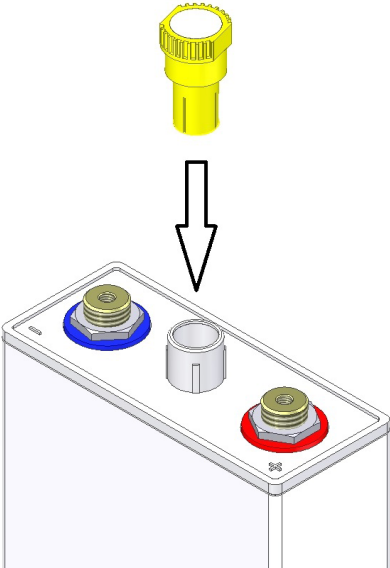

Step 2  
(before commissioning charge)

SOL 555-1680 G

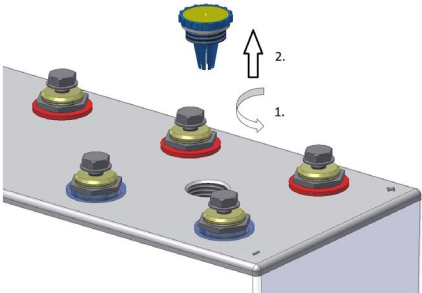

Step 1

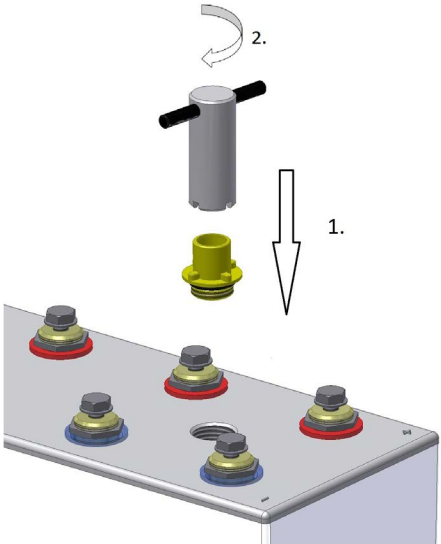

Step 2

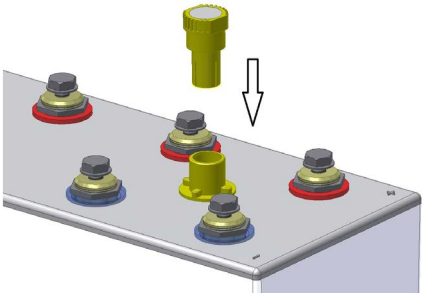

Step 3  
(before commissioning charge)

## 8. Layout details: inter-cell connection

### SOL 140-485 G

- 1 Cell
- 2 Cell connector
- 3 Spring washer
- 4 Screw
- 5 Connector cover

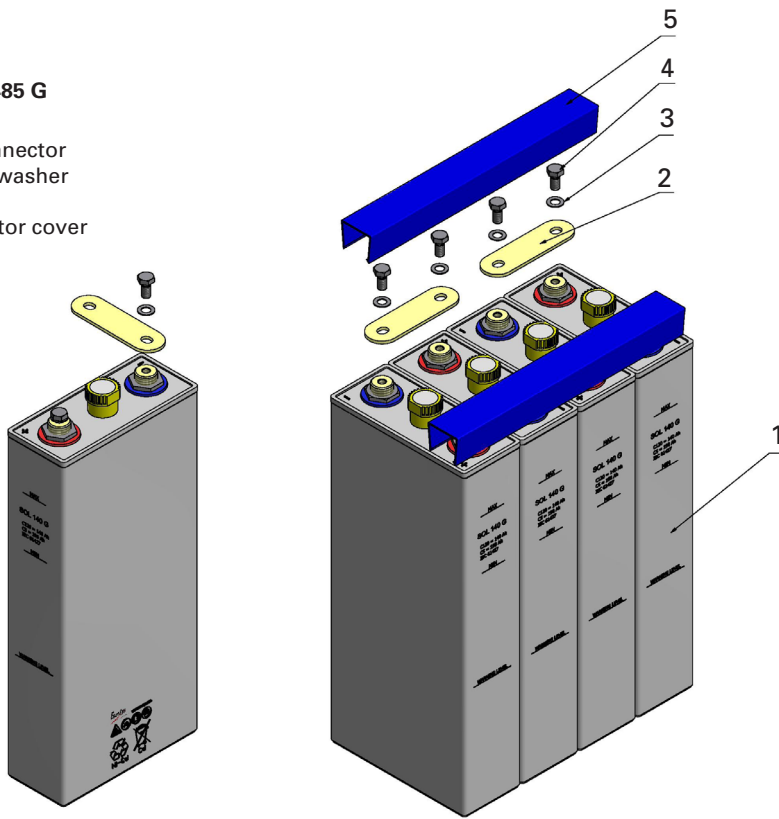

### SOL 555-1680 G

- 1 Cell
- 2 Cell connector
- 3 Terminal connector
- 4 Spring washer
- 5 Screw
- 6 Connector cover
- 7 End terminal connector
- 8 Cover and terminal connector

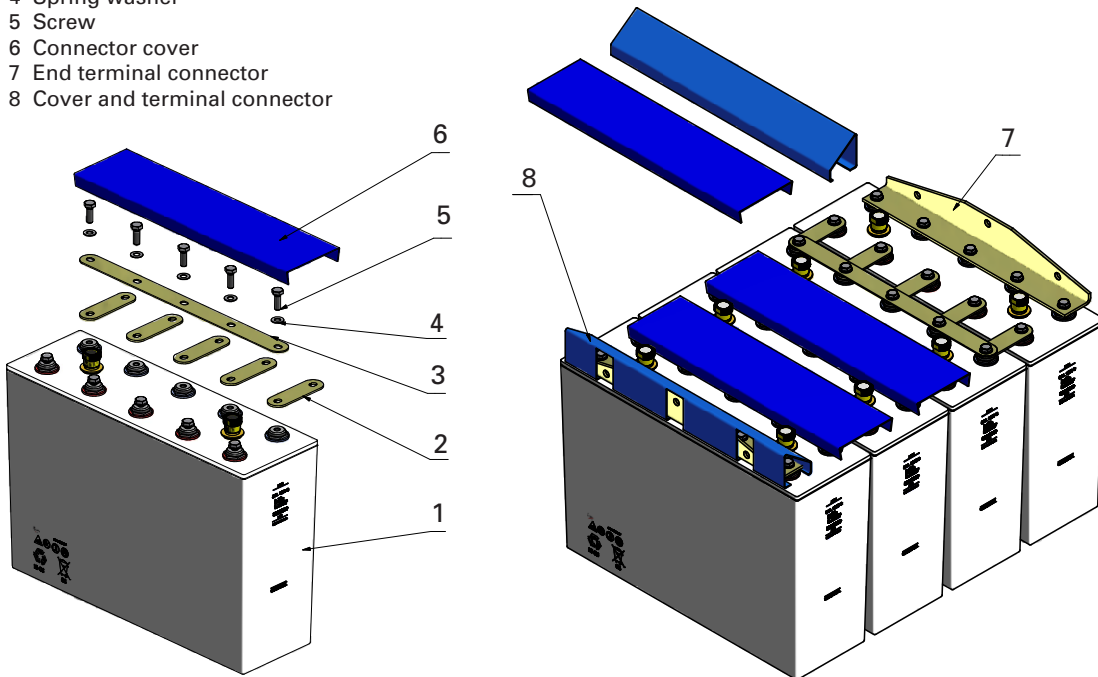

Note, typical layout only. Refer to section 9 for details

9. Cell Layout

SOL 140 G - SOL 310 G  
(Female thread M8)

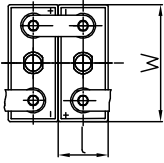

SOL 345 G - SOL 485 G  
(Female thread M10)

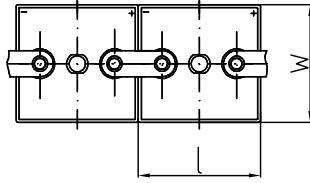

SOL 555 G - SOL 693 G  
(Female thread M10)

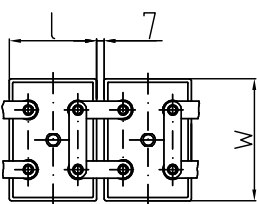

SOL 730 G - SOL 935 G  
(Female thread M10)

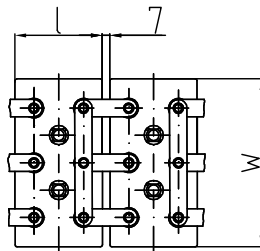

SOL 1110 G - SOL 1525 G  
(Female thread M10)

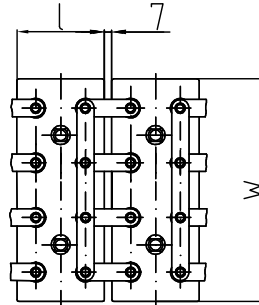

SOL 1680 G  
(Female thread M10)

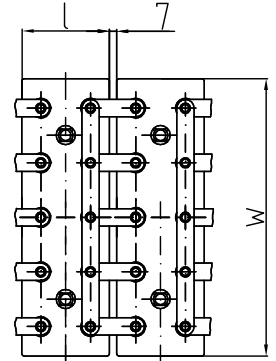

Cells assembled in a 2 row configuration

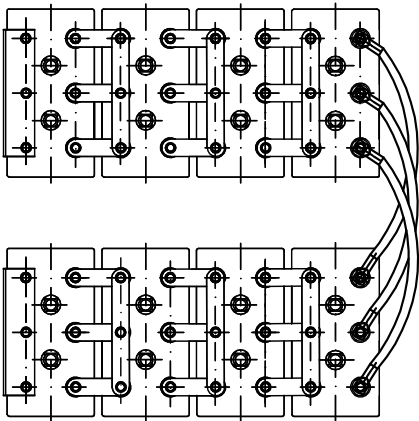



**EnerSys World Headquarters**  
2366 Bernville Road, Reading  
PA 19605, USA  
Tel: +1-610-208-1991 /  
+1-800-538-3627

**EnerSys EMEA**  
EH Europe GmbH  
Baarerstrasse 18  
6300 Zug, Switzerland

**EnerSys Asia**  
152 Beach Road  
Gateway East Building #11-03  
Singapore 189721  
Tel: +65 6508 1780

Contact